

A microscopic view of a biological chain structure, possibly a protein or DNA, with several spherical nodes connected by a central filament. The background is a soft-focus blue with some orange and yellow bokeh lights. The image is partially overlaid by a large blue arrow pointing to the right.

**AMNGENT**  
安进特

»»» 2025

# BIOSCIENCE CONSUMABLES

ZHEJIANG RONGDA BIOTECHNOLOGY CO., LTD.

— Focus on life sciences consumables —

# INTRODUCTION

Zhejiang Rongda Biotechnology Co., Ltd. was established in 2018. Our company's headquarter is located in Huangyan, Taizhou, an economically developed and scenic eastern coastal area in Zhejiang Province. We serve our customers with a science-based and quality-oriented spirit. Our company has a strong professional R&D team. At the same time, we have long-term cooperation with well-known domestic universities and scientific research institutions, and signed the contract of new products development and reagent experiments.

We adhere to the belief of "providing high-quality services for bioscience" and found the AMNGENT brand, focusing on cell culture, molecular biological consumables, biological sample library construction, safety management and the development and production of Class I and Class II diagnostic reagents. We continue to invest in high-end production equipment in the industry and introduce professional process technicians to form a new scientific management team. Our products have passed ISO9001, ISO13485, CE and other quality system certifications. AMNGENT continues to grow and develop, and our products are exported to companies in more than 80 countries and regions such as the United States and the European Union.

For the early-stage design and development of molds, our company also has a high-quality, professional and persistent team that makes full use of modern CAD/CAM design and the capabilities of a comprehensive CNC machining center to manufacture high-quality medical consumables and various molds.





# DIRECTORY

## LABORATORY CONSUMABLES SOLUTIONS

Centrifuge Tubes.....	02
Micro Centrifuge Tubes.....	05
Reagent Reservoir .....	06
Pipette Tips.....	07
Filter Pipette Tips.....	09
Pipette Tips Compatibility Chart.....	11
Pipette Tips For Rainin.....	12
5ml/10ml Pipette Tips .....	13
Transfer Pipettes .....	14
PCR Tubes.....	15
PCR Plates.....	16
Petri Dishes.....	17
Inoculating Loops&Needles .....	18
Cell Spreader.....	19
PC Conical Flasks.....	20
Gloves.....	21
Serological Pipettes.....	22
Cell Strainer .....	23
Cell Culture Dishes .....	24
Confocal Petri Dishes.....	25
Cell Culture Flasks .....	26
Cell Culture Plates.....	27
ELISA Plate.....	28

## BIOBANK CONSUMABLES SOLUTIONS

Traditional Cryogenic Vials.....	31
2D Cryogenic Vials.....	35
2D Automatic Cap Cryogenic Vials .....	37

# DIRECTORY

SBS Cryogenic Vials .....	38
Cardboard Cryo boxes .....	40
Hinged lid Cardboard Cryoboxes /Rivet Cryoboxes.....	41
PP Cryo boxes .....	42
PC Cryoboxes .....	43
Cell Freezing Container for 12 x 1ml or 2ml Cryo Tubes.....	44
Freezer Racks .....	45
Reader & Scanner .....	47
Semi-Automated Screw Cap Decapper/Recapper, Single Channel.....	47
Semi-Automated Screw Cap Decapper/Recapper, Multichannel.....	48
SBS Screw Cap Decapper/Recapper, full plate .....	48
Automated pipetting station.....	49
Recapper pipetting, Docking module.....	49
Cryogenic Vials CAPPING & DECAPPING .....	50
Low-temperature Label Printers & Labels.....	50
Sample Management Systems .....	51

## IVD CONSUMABLES SOLUTIONS

Screw cap micro tubes -lower cap,with O-Ring.....	53
Screw cap micro tubes --Hinged lower cap,with O-Ring.....	57
Screw cap micro tubes -lower cap,without O-Ring.....	58
Screw cap micro tubes -high cap,with O-Ring, Axygen line .....	59
Reagent bottle.....	60
Media Bottle.....	63
Sample tubes.....	65
Reagent Reservoir .....	66
Deep Well Plates .....	67
Hamilton Automatic Pipette Tips .....	68
Tecan Automatic Pipette.....	69
Beckman Automatic Pipette .....	70
Saliva Collectors.....	71



# LABORATORY CONSUMABLES SOLUTIONS

AMNGENT Provide standing consumables for biomedicine laboratory , including molecular biology, microbial detection, cell culture, and other general consumables, and provide customers with systematic consumable solutions.



# Centrifuge Tubes

## Product Feature

- Medical Grade material : PP tube & HDPE cap. USP and DMF report available
- Endotoxin free ,Non-Cytotoxin
- DNase & RNase free
- Heavy Metal free
- Sterile available
- Standard 100,000 clean workshop producing
- **CE**

Above mentioned can provide third-party reports or Associated product report





- 15ml & 50ml conical bottom, 50ml flat bottom . Sterility, foam rack and bag pack for option
- Scale range : within  $\pm 0.1$
- Tube two-tone UV printing, Black scale mark+ white
- writing area, Clearly identify
- White writing area suitable for watercolor pen,Mark pen,Whiteboard writing,clearly and tidy



- Double threaded cap design for one-handed operation
- Cap rotational screw thread design ,match with tube smooth and easy, matching without damping feel
- Sealing : under-90kap ,15mins testing,40°C constant temperature test .Test reports are available
- Temperature range: -86 to 121 °C (-186F to 250 F)
- Max RCF:15ml 12000G 50ML 9500G



Order No.	Volume	Bottom shape	Max RCF(g)	Sterile	Non-enzyme	Non-enzyme
220015	15ml	conical	12000	Yes	Yes	25pcs/bag,20bags/carton
220050	50ml	conical	9500	Yes	Yes	25pcs/bag,20bags/carton
220250	50ml	Self-standing	9500	Yes	Yes	25pcs/bag,20bags/carton
221015	15ml	conical	12000	Yes	Yes	50pcs/rack,10racks/carton
221050	50ml	conical	9500	Yes	Yes	25pcs/rack,20racks/carton
225015	15ml	conical	12000	No	Yes	100caps/bag,100tubes/bag,500sets/case
225050	50ml	conical	9500	No	Yes	100caps/bag,100tubes/bag,500sets/case

## Dimension

Unit: mm

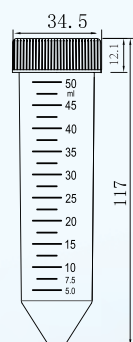

50ml  
220050/221050

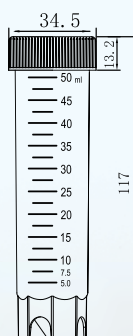

50ml  
220250



15ml  
220015/221015



# Micro Centrifuge Tubes

## Product Feature

- Medical Grade PP material
- Volume Options: 0.5ml 0.6ml 1.5ml 2.0ml
- Highly Transparent tube ,easy for observe. Clear Graduations and frosted marking area
- Special safe lock cap design ,easy for one hand open
- Flat cap easy for writing and label
- DNase & RNase free ,Non-endotoxin
- Temperature range: -86 to 121 °C (-186F to 250 F)
- Max RCF: 16000G



Item No.	Volume	Low Retention	Sterile	Non-enzyme	Packaging Specification
240005	0.5ml	No	No	Yes	500pcs/bag,10bags/carton
240006	0.6ml	No	No	Yes	500pcs/bag,10bags/carton
240015	1.5ml	No	No	Yes	500pcs/bag,10bags/carton
240020	2.0ml	No	No	Yes	500pcs/bag,10bags/carton
241006	0.6ml	Yes	No	Yes	500pcs/bag,10bags/carton
241015	1.5ml	Yes	No	Yes	500pcs/bag,10bags/carton
241020	2.0ml	Yes	No	Yes	500pcs/bag,10bags/carton
240106	0.6ml	No	Yes	Yes	50pcs/bag,10bags/pack , 4pack/carton
240115	1.5ml	No	Yes	Yes	50pcs/bag,10bags/pack , 4pack/carton
240120	2.0ml	No	Yes	Yes	50pcs/bag,10bags/pack , 4pack/carton

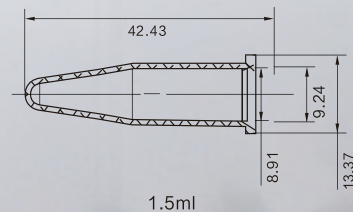
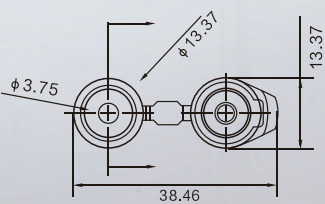

Dimensions=mm

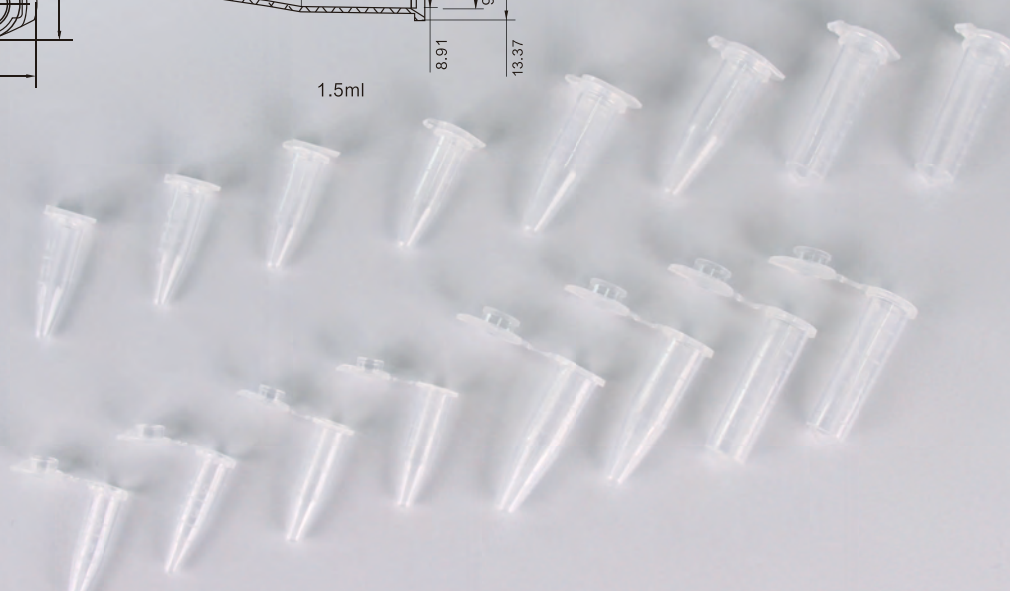



# Reagent Reservoir

## Product Feature

- Color & Material Options : PS white and PVC clear
- Volume : 10ml, 25ml, 55ml , 100ml
- Package : white PS individual package,sterile, U shape bag easy for peel off  
PVC clear bulk pack

Item No.	Volume	Material	Sterile	Non-enzyme	Packing	Packaging Specifications
280010	10ml	PS	Yes	Yes	Individual	100pcs/carton
280025	25ml	PS	Yes	Yes	Individual	100pcs/carton
280050	55ml	PS	Yes	Yes	Individual	100pcs/carton
280100	100ml	PS	Yes	Yes	Individual	100pcs/carton
280051	55ml	PVC	No	No	Bulk	100pcs/bag,6bags/carton

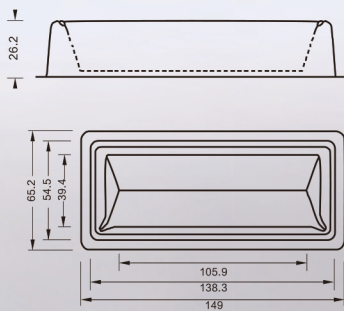

280050/280051

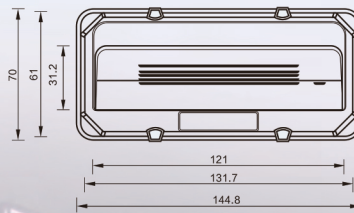

280025

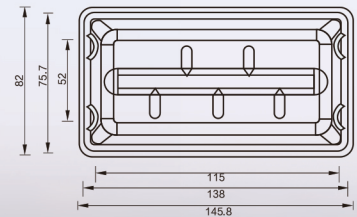

280100

Dimensions=mm





# Pipette Tips

## Product Feature

- Medical Grade PP
- Product options : Normal & Low retention
- Volume options : 10ul 10ul longer 200ul 300ul 1000ul 1250ul
- Suitable for : manual operation and Electronic pipettor
- DNase & RNase free ,Non-Pyrogen
- Package : Bag pack, Reload system, Rack pack for options
- Withstand 121°C high temperature and high pressure sterile

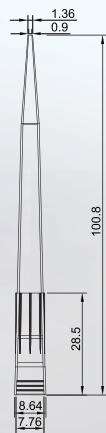

1250ul

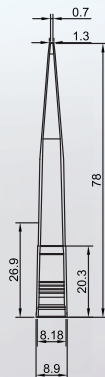

1000ul

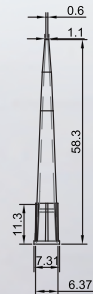

300ul

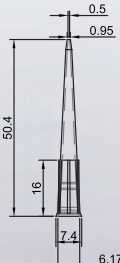

200ul

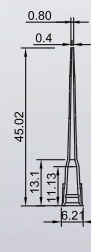

10ul加长

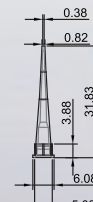

10ul

Dimensions=mm

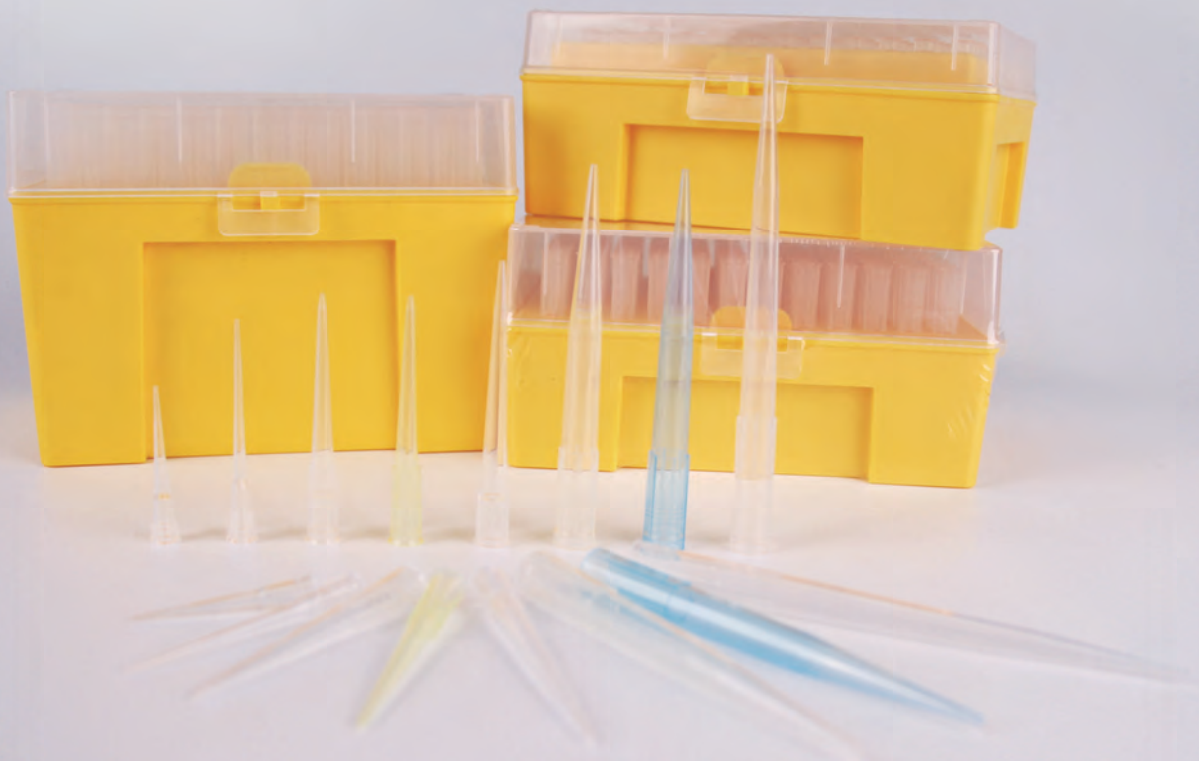

Item No.	Volume	Color	Low adsorption	Sterile	Non-enzyme	Packaging Specifications
430010	10µL	Transparent	No	No	Yes	Bagged, 1000tips/bag, 10bags/carton
440010	10µL	Transparent	No	Yes	Yes	Racked, 96tips/rack , 50racks/box
460010	10µL	Transparent	No	No	Yes	Stacked, 96tips/stack, 10stacks/inner, 10inners/carton
450010	10µL	Transparent	Yes	Yes	Yes	Racked, 96tips/rack , 50racks/box
470010	10µL	Transparent	Yes	No	Yes	Stacked, 96tips/stack, 10stacks/inner, 10inners/carton
430011	10µL longer	Transparent	No	No	Yes	Bagged, 500tips/bag, 20bags/carton
440011	10µL longer	Transparent	No	Yes	Yes	Racked, 96tips/rack , 50racks/box
460011	10µL longer	Transparent	No	No	Yes	Stacked, 96tips/stack, 10stacks/inner, 10inners/carton
450011	10µL longer	Transparent	Yes	Yes	Yes	Racked, 96tips/rack , 50racks/box
470011	10µL longer	Transparent	Yes	No	Yes	Stacked, 96tips/stack, 10stacks/inner, 10inners/carton
430200	200µL	Transparent yellow	No	No	Yes	Bagged, 1000tips/bag, 10bags/carton
430201	200µL	Transparent	No	No	Yes	Bagged, 1000tips/bag, 10bags/carton
440200	200µL	Transparent yellow	No	Yes	Yes	Racked, 96tips/rack , 50racks/box
440201	200µL	Transparent	No	Yes	Yes	Racked, 96tips/rack , 50racks/box
460200	200µL	Transparent yellow	No	No	Yes	Stacked, 96tips/stack, 10stacks/inner, 10inners/carton
450200	200µL	Transparent yellow	Yes	Yes	Yes	Racked, 96tips/rack , 50racks/box
470200	200µL	Transparent yellow	Yes	No	Yes	Stacked, 96tips/stack, 10stacks/inner, 10inners/carton
430301	300µL	Transparent	No	No	Yes	Bagged, 1000tips/bag, 10bags/carton
440301	300µL	Transparent	No	Yes	Yes	Racked, 96tips/rack , 50racks/box
460300	300µL	Transparent	No	No	Yes	Stacked, 96tips/stack, 10stacks/inner, 10inners/carton
470300	300µL	Transparent	Yes	No	Yes	Stacked, 96tips/stack, 10stacks/inner, 10inners/carton
431000	1000µL	Transparent blue	No	No	Yes	Bagged, 1000tips/bag, 10bags/carton
431001	1000µL	Transparent	No	No	Yes	Bagged, 1000tips/bag, 10bags/carton
441000	1000µL	Transparent blue	No	Yes	Yes	Racked, 96tips/stack , 30racks/box
441001	1000µL	Transparent	No	Yes	Yes	Racked, 96tips/stack , 30racks/box
461000	1000µL	Transparent blue	No	No	Yes	Stacked, 96tips/stack, 8stacks/inner, 10inners/carton
451000	1000µL	Transparent blue	Yes	Yes	Yes	Racked, 96tips/stack , 30racks/box
471000	1000µL	Transparent blue	Yes	No	Yes	Stacked, 96tips/stack, 8stacks/inner, 10inners/carton
431250	1250µL	Transparent	No	No	Yes	Bagged, 500pcs/bag, 10bags/carton
441250	1250µL	Transparent	No	Yes	Yes	Racked, 96tips/stack , 30racks/box
461250	1250µL	Transparent	No	No	Yes	Stacked, 96tips/stack, 8stacks/inner, 10inners/carton
451250	1250µL	Transparent	Yes	Yes	Yes	Racked, 96tips/stack , 30racks/box
471250	1250µL	Transparent	Yes	No	Yes	Stacked, 96tips/stack, 8stacks/inner, 10inners/carton

# Filter Pipette Tips

## Product Feature

- Medical Grade PP
- Product options : Normal & Low retention
- Volume options : 10ul 10ul longer 20ul 50ul 100ul 200ul 200ul longer 300ul 1000ul 1250ul
- DNase & RNase free ,Non-Pyrogen
- Package : Bag pack, Reload system, Rack pack for options

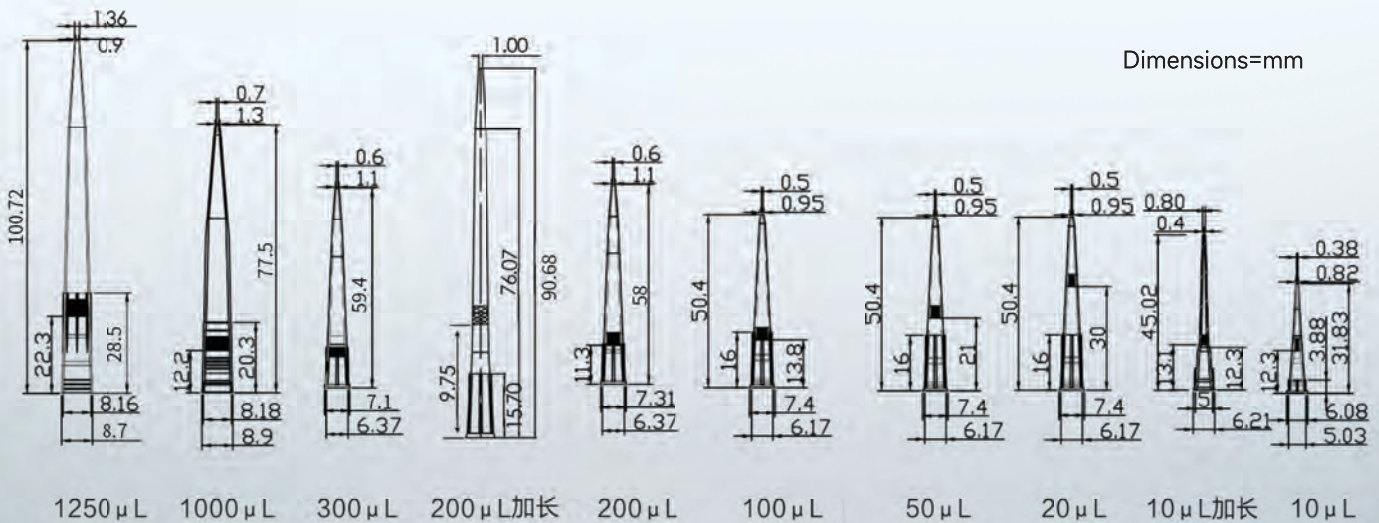
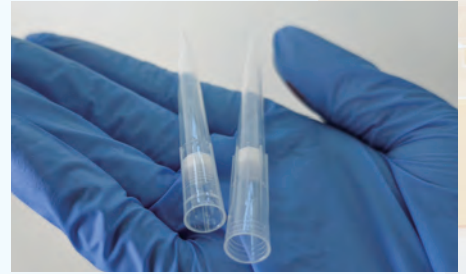

Item No.	Volume	Color	Low adsorption	Sterile	Non-enzyme	Packaging Specifications
400010	10µL	Transparent	No	No	Yes	Bagged, 1000tips/bag, 10bags/carton
420010	10µL	Transparent	No	Yes	Yes	Racked, 96tips/rack ,10racks/inner, 50racks/carton
480010	10µL	Transparent	Yes	Yes	Yes	Racked, 96tips/rack ,10racks/inner, 50racks/carton
400011	10µL longer	Transparent	No	No	Yes	Bagged, 500tips/bag, 20bags/carton
420011	10µL longer	Transparent	No	Yes	Yes	Racked, 96tips/rack ,10racks/inner, 50racks/carton
480011	10µL longer	Transparent	Yes	Yes	Yes	Racked, 96tips/rack ,10racks/inner, 50racks/carton
400020	20µL	Transparent	No	No	Yes	Bagged, 1000tips/bag, 10bags/carton
420020	20µL	Transparent	No	Yes	Yes	Racked, 96tips/rack ,10racks/inner, 50racks/carton
480020	20µL	Transparent	Yes	Yes	Yes	Racked, 96tips/rack ,10racks/inner, 50racks/carton
400050	50µL	Transparent	No	No	Yes	Bagged, 1000tips/bag, 10bags/carton
420050	50µL	Transparent	No	Yes	Yes	Racked, 96tips/rack ,10racks/inner, 50racks/carton
480050	50µL	Transparent	Yes	Yes	Yes	Racked, 96tips/rack ,10racks/inner, 50racks/carton
400100	100µL	Transparent	No	No	Yes	Bagged, 1000tips/bag, 10bags/carton
420100	100µL	Transparent	No	Yes	Yes	Racked, 96tips/rack ,10racks/inner, 50racks/carton
480100	100µL	Transparent	Yes	Yes	Yes	Racked, 96tips/rack ,10racks/inner, 50racks/carton
400200	200µL	Transparent	No	No	Yes	Bagged, 1000tips/bag, 10bags/carton
420200	200µL	Transparent	No	Yes	Yes	Racked, 96tips/rack ,10racks/inner, 50racks/carton
420201	200µL longer	Transparent	No	Yes	Yes	Racked, 96tips/rack ,10racks/inner, 50racks/carton
480200	200µL	Transparent	Yes	Yes	Yes	Racked, 96tips/rack ,10racks/inner, 50racks/carton
400300	300µL	Transparent	No	No	Yes	Bagged, 1000tips/bag, 10bags/carton
420300	300µL	Transparent	No	Yes	Yes	96tips/rack , 8racks/inner, 40racks/carton
480300	300µL	Transparent	Yes	Yes	Yes	96tips/rack , 8racks/inner, 40racks/carton
401000	1000µL	Transparent	No	No	Yes	Bagged, 1000tips/bag, 10bags/carton
421000	1000µL	Transparent	No	Yes	Yes	96tips/rack ,6racks/inner, 30racks/carton
481000	1000µL	Transparent	Yes	Yes	Yes	96tips/rack ,6racks/inner, 30racks/carton
401250	1250µL	Transparent	No	No	Yes	Bagged, 500tips/bag, 10bags/carton
421250	1250µL	Transparent	No	Yes	Yes	96tips/rack ,6racks/inner, 30racks/carton
481250	1250µL	Transparent	Yes	Yes	Yes	96tips/rack ,6racks/inner, 30racks/carton





# Pipette Tips For Rainin

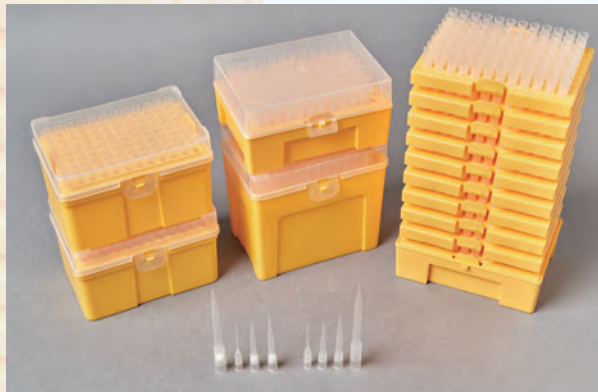

## Product Feature

- Medical Grade PP
- Suitable for LTS pipettor
- Product options : Normal & Low retention
- Volume options : 20ul 200ul 300ul 1000ul 1200ul
- DNase & RNase free ,Non-Pyrogen
- Package : Bag pack, Reload system, Rack pack for options

Item No.	Filter	Volume	Low adsorption	Sterile	Non-enzyme	Packaging Specifications
R430020	Without	20µL	No	No	Yes	500tips/bag,20bags/carton
R430200	Without	200µL	No	No	Yes	1000tips/bag,10bags/carton
R430300	Without	300µL	No	No	Yes	1000tips/bag,10bags/carton
R431000	Without	1000µL	No	No	Yes	1000tips/bag,5bags/carton
R431200	Without	1200µL	No	No	Yes	1000tips/bag,5bags/carton
R460020	Without	20µL	No	No	Yes	Reload system,96tip/rack, 10rack/inner,10inner/carton
R460200	Without	200µL	No	No	Yes	Reload system,96tip/rack,10rack/inner,10inner/carton
R460300	Without	300µL	No	No	Yes	Reload system,96tip/rack,10rack/inner,10inner/carton
R461000	Without	1000µL	No	No	Yes	Reload system,96tip/rack,8rack/inner,10inner/carton
R440020	Without	20µL	No	Yes	Yes	96tips/rack,10racks/inner,5inners/carton
R440200	Without	200µL	No	Yes	Yes	96tips/rack,10racks/inner,5inners/carton
R440300	Without	300µL	No	Yes	Yes	96tips/rack,10racks/inner,5inners/carton
R441000	Without	1000µL	No	Yes	Yes	96tips/rack,10racks/inner,5inners/carton
R441200	Without	1200µL	No	Yes	Yes	96tips/rack,10racks/inner,5inners/carton
R450020	Without	20µL	Yes	Yes	Yes	96tips/rack,10racks/inner,5inners/carton
R450200	Without	200µL	Yes	Yes	Yes	96tips/rack,10racks/inner,5inners/carton
R450300	Without	300µL	Yes	Yes	Yes	96tips/rack,10racks/inner,5inners/carton
R451000	Without	1000µL	Yes	Yes	Yes	96tips/rack,10racks/inner,5inners/carton
R451200	Without	1200µL	Yes	Yes	Yes	96tips/rack,10racks/inner,5inners/carton
R400020	With filter	20µL	No	Yes	Yes	500tips/bag,20bags/carton
R400200	With filter	200µL	No	Yes	Yes	1000tips/bag,10bags/carton
R400300	With filter	300µL	No	Yes	Yes	1000tips/bag,10bags/carton
R401000	With filter	1000µL	No	Yes	Yes	1000tips/bag,5bags/carton
R401200	With filter	1200µL	No	No	Yes	1000tips/bag,5bags/carton
R420020	With filter	20µL	No	Yes	Yes	96tips/rack,10racks/inner,5inners/carton
R420200	With filter	200µL	No	Yes	Yes	96tips/rack,10racks/inner,5inners/carton
R420300	With filter	300µL	No	Yes	Yes	96tips/rack,10racks/inner,5inners/carton
R421000	With filter	1000µL	No	Yes	Yes	96tips/rack,10racks/inner,5inners/carton
R421200	With filter	1200µL	No	Yes	Yes	96tips/rack,10racks/inner,5inners/carton
R480020	With filter	20µL	Yes	Yes	Yes	96tips/rack,10racks/inner,5inners/carton
R480200	With filter	200µL	Yes	Yes	Yes	96tips/rack,10racks/inner,5inners/carton
R480300	With filter	300µL	Yes	Yes	Yes	96tips/rack,10racks/inner,5inners/carton
R481000	With filter	1000µL	Yes	Yes	Yes	96tips/rack,10racks/inner,5inners/carton
R481200	With filter	1200µL	Yes	Yes	Yes	96tips/rack,10racks/inner,5inners/carton

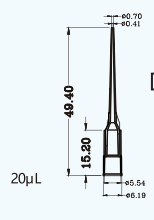
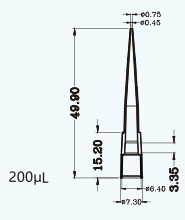
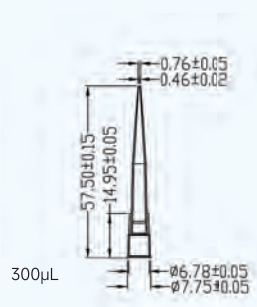
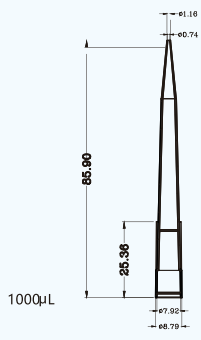
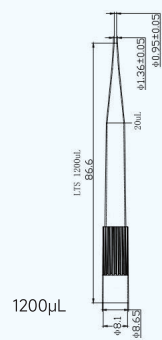

Dimensions=mm

# 5ml/10ml Pipette Tips

## Product Feature

- Compatible with many pipettes brands
- Clear scale mark, transparent body and the volume can be visually confirmed
- No DNase, RNA enzyme, no pyrogen
- Can be sterilized under high pressure, with a temperature tolerance range of -80~121°C

Item No.	Volume	Color	Filter	Non-enzyme	Packing
6002005-D	5ml	Transparent	Without	✓	100pcs/bag,10 bags/case
6003005-D	5ml	Transparent	Without	✓	100pcs/bag,10 bags/case
6001005-D	5ml	Transparent	Without	✓	100pcs/bag,10 bags/case
6001010-D	10ml	Transparent	Without	✓	100pcs/bag,10 bags/case
6002010-D	10ml	Transparent	Without	✓	100pcs/bag,10 bags/case
6002005-H	5ml	Transparent	Without	✓	40pcs/rack,16 racks/case
6003005-H	5ml	Transparent	Without	✓	24pcs/rack,16 racks/case
6001005-H	5ml	Transparent	Without	✓	24pcs/rack,16 racks/case
6001010-H	10ml	Transparent	Without	✓	24pcs/rack,16 racks/case
6002010-H	10ml	Transparent	Without	✓	24pcs/rack,16 racks/case
7002005-H	5ml	Transparent	With filter	✓	40pcs/rack,16 racks/case
7003005-H	5ml	Transparent	With filter	✓	24pcs/rack,16 racks/case
7001005-H	5ml	Transparent	With filter	✓	24pcs/rack,16 racks/case
7001010-H	10ml	Transparent	With filter	✓	24pcs/rack,16 racks/case
7002010-H	10ml	Transparent	With filter	✓	24pcs/rack,16 racks/case

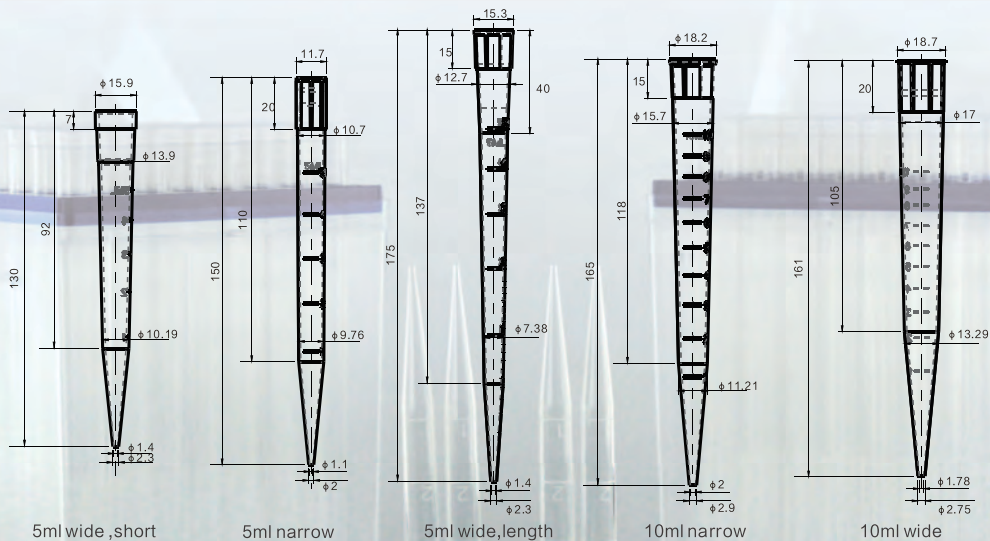

# Transfer Pipettes

## Product Feature



- High Quality PE material, high toughness, high transparency
- Tube Body and Bulk thickening design, easy for dropper and cell blowing
- Elastic suction pouch, Good Rebound recovery
- Slender and soft, Easy to transfer liquids quickly, instead of rubber dropper
- Sterile 15kgy
- Pack : Plastic-paper individually packed and bulk packed

Item No.	Volume	Length	Sterile	Non-enzyme	Packing	Packaging Specifications
330001	1ml	159mm	No	No	Bulk	500pcs/rack, 2000pcs/carton
330011	1ml	159mm	Yes	Yes	Individual	500pcs/rack, 2000pcs/carton
330201	2ml	155mm	No	No	Bulk	500pcs/rack, 2000pcs/carton
330211	2ml	155mm	Yes	Yes	Individual	500pcs/rack, 2000pcs/carton
330301	3ml	160mm	No	No	Bulk	500pcs/rack, 2000pcs/carton
330311	3ml	160mm	Yes	Yes	Individual	500pcs/rack, 2000pcs/carton
330302	3ml加长	185mm	No	No	Bulk	500pcs/rack, 2000pcs/carton
330312	3ml加长	185mm	Yes	Yes	Individual	500pcs/rack, 2000pcs/carton

Dimensions=mm

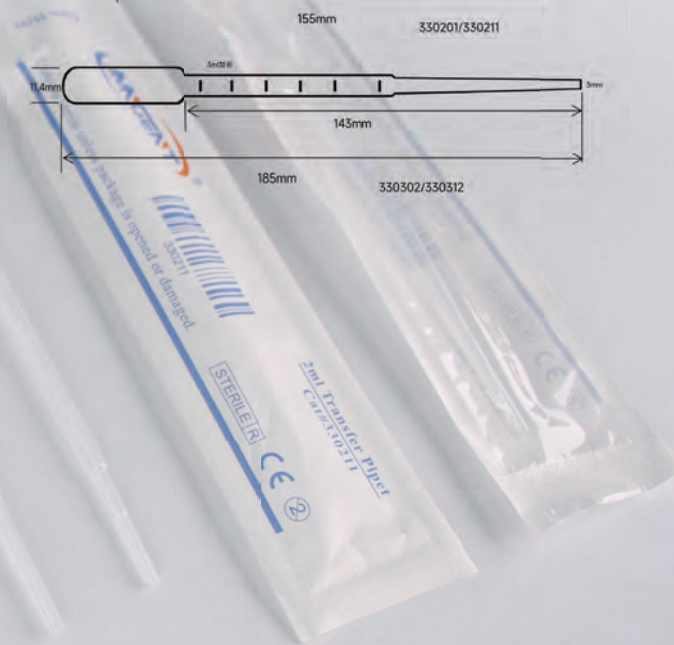
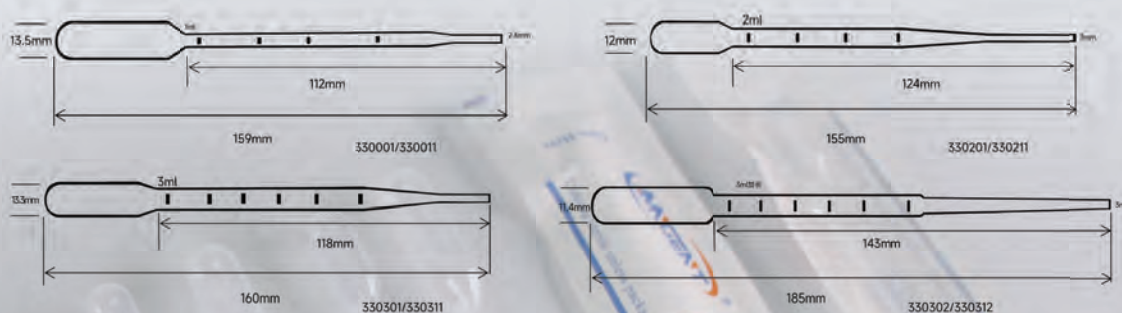



# PCR Tubes

## Product Feature

- Medical Grade PP
- Ultrathin tube, Extremely fast temperature conduction
- Flat cap design, suitable for real-time quantification PCR test
- Sealed design, Effectively avoid exploding cap problems
- DNase & RNase free ,Non-Pyrogen
- Working temperature : -20degree -100degree , suitable for normal brand PCR machine, support for fully supported rotor
- Centrifugal force: 6000G



Order No.	Volume	Color	Color	Cap	Non-enzyme	Packing
310008	0.1ml,8-strip	Transparent	AXYGEN	Flat	Yes	125pcs/rack, 10racks/case
310108	0.1ml,8-strip	White	AXYGEN	Flat	Yes	125pcs/rack, 10racks/case
311008	0.1ml,8-strip	Transparent	Roche	Flat	Yes	125pcs/rack, 10racks/case
311108	0.1ml,8-strip	White	Roche	Flat	Yes	125pcs/rack, 10racks/case
320002	0.2ml,single	Transparent	General	Flat	Yes	1000pcs/rack, 10racks/case
320108	0.2ml,8-strip	Transparent	AXYGEN	Flat	Yes	125pcs/rack, 10racks/case
320128	0.2ml,8-strip	Transparent	Roche	Flat	Yes	125pcs/rack, 10racks/case
320158	0.2ml,8-strip	Transparent	General	Convex	Yes	125pcs/rack, 10racks/case

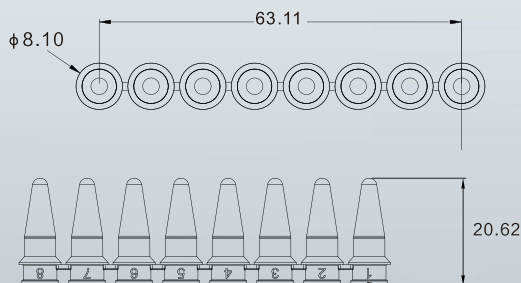

320108

Dimensions=mm

# PCR Plates

## Product Feature

- 1. Medical grade polypropylene material
- 2. Ultra-thin tube wall, extremely fast temperature conduction
- 3. Suitable for real-time fluorescence quantitative experiments
- 4. Available in non-skirt, half skirt and full skirt
- 5. Elevated edge of the hole can better prevent cross contamination, and the plate design better for self-adhesive film
- 6. DNase free, RNase free, Endotoxin free
- 7. Sealing film is made of medical grade polypropylene
- 8. No autofluorescence to ensure experimental accuracy
- 9. Pressure-sensitive film to improve experimental convenience and optical data accuracy

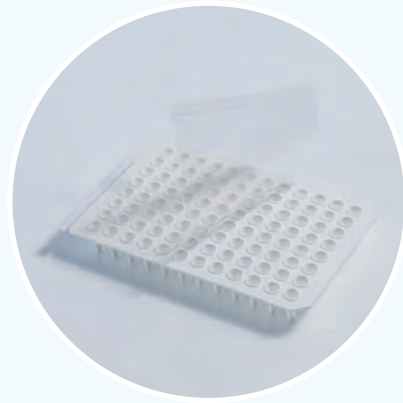

Order No.	Volume	Color	Skirt	Type	Non-enzyme	Packing
310196	0.1ml	Transparent	Non-skirt	General	Yes	10pcs/bag, 50pcs/case
310096	0.1ml	Transparent	Half-skirt	Roche	Yes	10pcs/bag, 50pcs/case
313196	0.1ml	White	Non-skirt	General	Yes	10pcs/bag, 50pcs/case
313096	0.1ml	White	Half-skirt	Roche	Yes	10pcs/bag, 50pcs/case
310396	0.1ml	Transparent	Half-skirt	ABI	Yes	10pcs/bag, 50pcs/case
310596	0.1ml	Transparent	Full-skirt	Workstation	Yes	10pcs/bag, 50pcs/case
313596	0.1ml	White	Full-skirt	Workstation	Yes	10pcs/bag, 50pcs/case
320196	0.2ml	Transparent	Non-skirt	General	Yes	10pcs/bag, 50pcs/case
320096	0.2ml	Transparent	Half-skirt	Roche	Yes	10pcs/bag, 50pcs/case
323196	0.2ml	White	Non-skirt	General	Yes	10pcs/bag, 50pcs/case
323096	0.2ml	White	Half-skirt	Roche	Yes	10pcs/bag, 50pcs/case
320396	0.2ml	Transparent	Half-skirt	ABI	Yes	10pcs/bag, 50pcs/case
326000(sealing film)	—	Transparent	—	—	Yes	100pcs/case
326010(sealing film)	—	Transparent	—	—	Yes	100pcs/case
326020(sealing film)	—	Transparent	—	—	Yes	100pcs/case

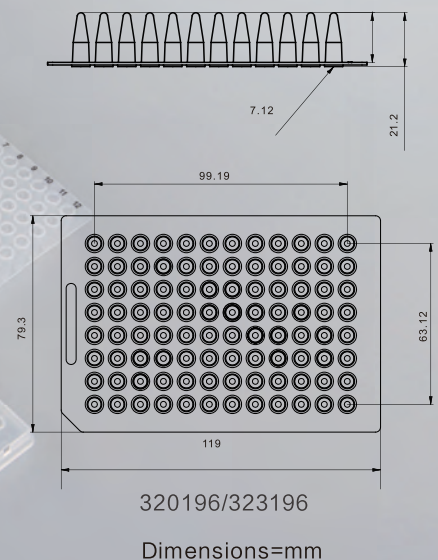
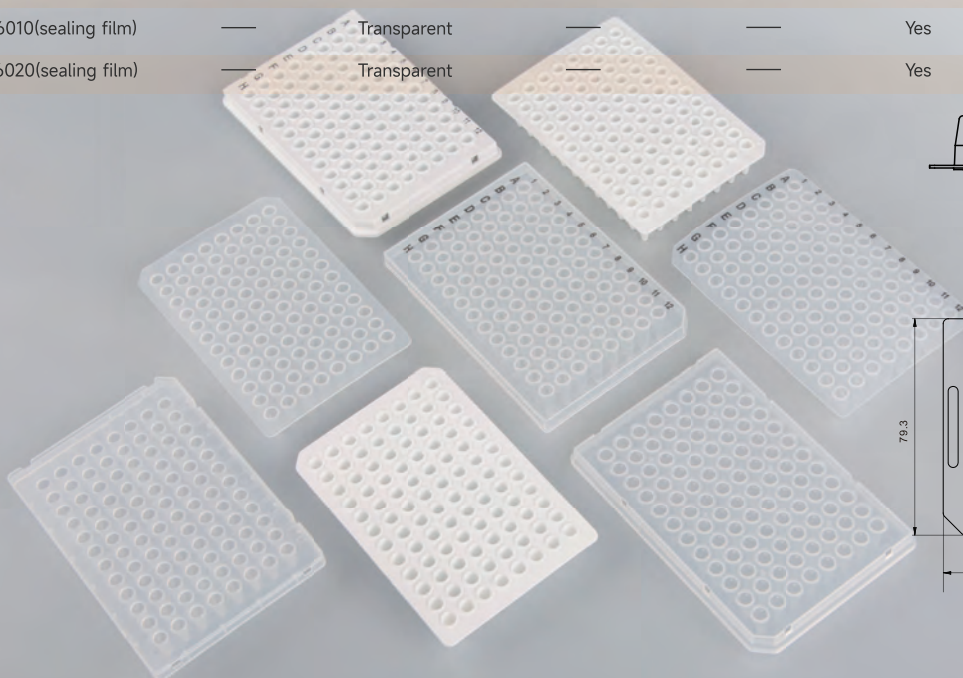

# Petri Dishes

## Product Feature

- Medical grade PS
- 60mm 90mm 150mm size for options
- Breathable design facilitates gas exchange
- Stacking design



Order No.	Product Size	Color	Sterile	Packing
401560	60mm	Transparent	Yes	10pcs/bag,50bags/case
401690	90mm	Transparent	Yes	10pcs/bag,50bags/case
401515	150mm	Transparent	Yes	10pcs/bag,20bags/case

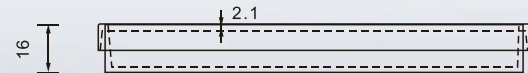
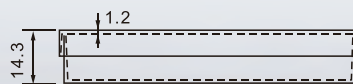
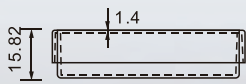
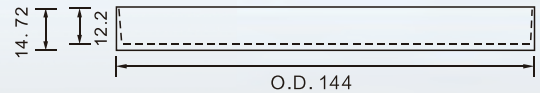
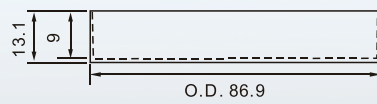
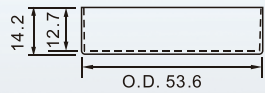
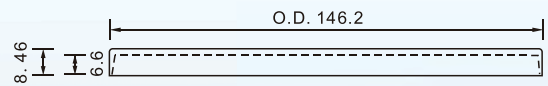
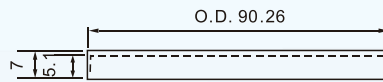
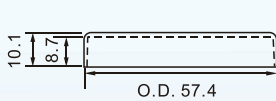

401560

401690

401515

Dimensions=mm

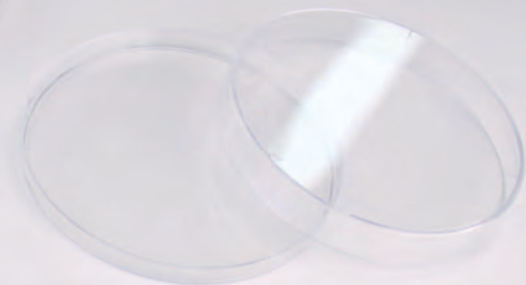



# Inoculating Loops&Needles

## Product Feature

- Medical grade HIPS material
- High product toughness, Convenient for marking and point planting
- Size 1ul and 10ul ,high Accuracy of inoculation volume
- The other end ok use for indicating needle
- E-beam sterile
- Sealed bag, cardboard instruction sheet inside , protect product with good shape .

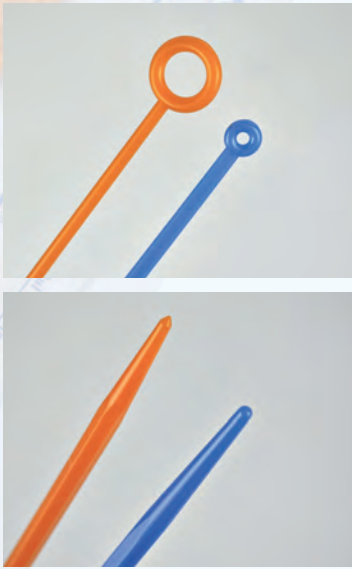

Order No.	Volume	Color	Sterile	Non-enzyme	Packing
550001	1µl	Blue	Yes	Yes	25pcs/bag,40bag/case
550101	1µl	Blue	Yes	Yes	Individually Wrapped , 500pcs/case
550002	10µl	Orange	Yes	Yes	25pcs/bag,40bag/case
550102	10µl	Orange	Yes	Yes	Individually Wrapped , 500pcs/case

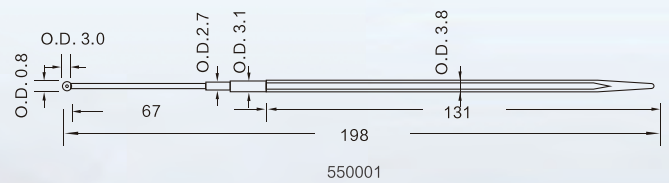
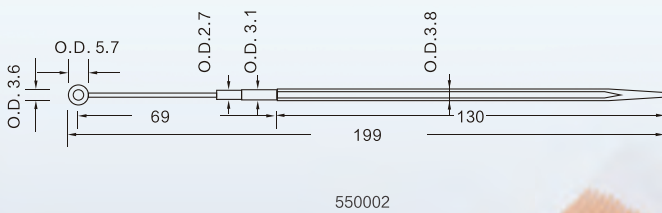

Dimensions=mm





# Cell Spreader

## Product Feature

- Medical grade HIPS material
- Smooth surface ,Tail upward design reduces damage to the AGAR surface
- L-shape design easy for use
- E-beam sterile
- Pack : Plastic-paper individually packed and bulk packed



Order No.	Color	Sterile	Non-enzyme	Packing
560001	Orange	Yes	Yes	500pcs/case
560010	Orange	Yes	Yes	10pcs/bag,50bags/case

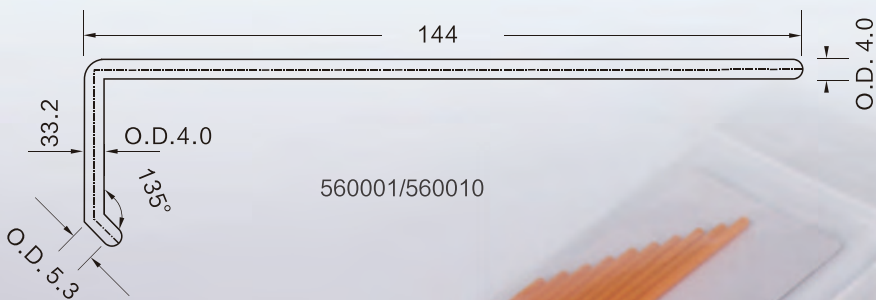

Dimensions=mm



Dimensions=mm

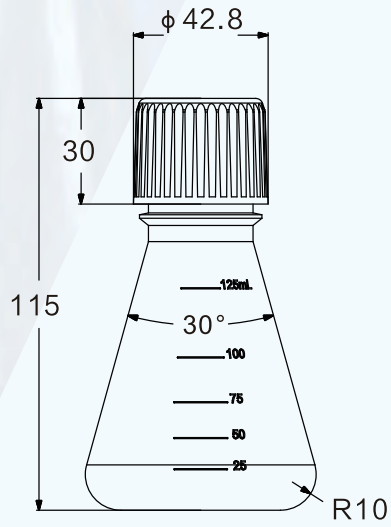

570125

## PC Conical Flasks

### Product Feature

- Medical grade PC
- More volume options
- Cap options: sealed cap , 0.2um Vent cap
- Temperature range : **-80°C~121°C**
- E-beam sterile
- DNase & RNase free ,Non-Pyrogen

Order No.	Volume	Sterile	Non-enzyme	Packing
570125	125ml	Yes	Yes	1pcs/bag,24pcs/case
570250	250ml	Yes	Yes	1pcs/bag,12pcs/case
570500	500ml	Yes	Yes	1pcs/bag,12pcs/case
571000	1000ml	Yes	Yes	1pcs/bag,6pcs/case
572800	2.8L	Yes	Yes	1pcs/bag,6pcs/case
575000	5L	Yes	Yes	1pcs/bag,4pcs/case



# Gloves

## Product Feature

- Style : Powder free latex & nitrile gloves for options
- Hypoallergenic, imported from Malaysia, Protein free, no allergic reaction
- Glove pattern design, convenient matching grasp operation
- CE and pass the biocompatibility test

Order No.	Material	Size	Color	Packing
520001	Nitrile	XS	Blue	100pcs/rack,10racks/case
520002	Nitrile	S	Blue	100pcs/rack,10racks/case
520003	Nitrile	M	Blue	100pcs/rack,10racks/case
520004	Nitrile	L	Blue	100pcs/rack,10racks/case
520005	Nitrile	XL	Blue	100pcs/rack,10racks/case
530001	Latex	XS	Natural	100pcs/rack,10racks/case
530002	Latex	S	Natural	100pcs/rack,10racks/case
530003	Latex	M	Natural	100pcs/rack,10racks/case
530004	Latex	L	Natural	100pcs/rack,10racks/case
530005	Latex	XL	Natural	100pcs/rack,10racks/case





# Serological Pipettes

## Product Feature

- Medical grade PS material
- Volume options : 1ml ---100ml 7 different colors
- Ascending and descending bi-directional scale design can intuitively read the amount of remaining liquid
- The polyolefin filter element can effectively prevent the damage of excessive suction to pipetting equipment
- E-beam sterile ,Non pyrogens, non cytotoxins, DNase& RNase free
- Package style : paper-plastic ;plastic -plastic bag for options, effectively prevent pollution, convenient access



Order No.	Volume	Color	pipette Nozzle style	Sterile	Non-enzyme	Style	Packing
720001	1ml	Yellow	one piece (extrusion style)	Yes	Yes	Individually Wrapped,paper-plastic Bag	50pcs/bag,10bags/case
720002	2ml	Green	one piece (extrusion style)	Yes	Yes	Individually Wrapped,paper-plastic Bag	50pcs/bag,10bags/case
720005	5ml	Blue	one piece (extrusion style)	Yes	Yes	Individually Wrapped,paper-plastic Bag	50pcs/bag,10bags/case
720010	10ml	Orange	two pieces (sonic welding style)	Yes	Yes	Individually Wrapped,paper-plastic Bag	50pcs/bag,8bags/case
720025	25ml	Red	two pieces (sonic welding style)	Yes	Yes	Individually Wrapped,paper-plastic Bag	25pcs/bag,8bags/case
720050	50ml	Black	two pieces (sonic welding style)	Yes	Yes	Individually Wrapped,paper-plastic Bag	25pcs/bag,4bags/case
720100	100ml	Purple	two pieces (sonic welding style)	Yes	Yes	Individually Wrapped,paper-plastic Bag	25pcs/bag,4bags/case
721001	1ml	Yellow	one piece (extrusion style)	Yes	Yes	Individually Wrapped,plastic Bag	50pcs/bag,10bags/case
721002	2ml	Green	one piece (extrusion style)	Yes	Yes	Individually Wrapped,plastic Bag	50pcs/bag,10bags/case
721005	5ml	Blue	one piece (extrusion style)	Yes	Yes	Individually Wrapped,plastic Bag	50pcs/bag,10bags/case
721010	10ml	Orange	one piece (extrusion style)	Yes	Yes	Individually Wrapped,plastic Bag	50pcs/bag,8bags/case
721025	25ml	Red	two pieces (sonic welding style)	Yes	Yes	Individually Wrapped,plastic Bag	25pcs/bag,8bags/case
721050	50ml	Black	two pieces (sonic welding style)	Yes	Yes	Individually Wrapped,plastic Bag	25pcs/bag,4bags/case
721100	100ml	Purple	two pieces (sonic welding style)	Yes	Yes	Individually Wrapped,plastic Bag	25pcs/bag,4bags/case

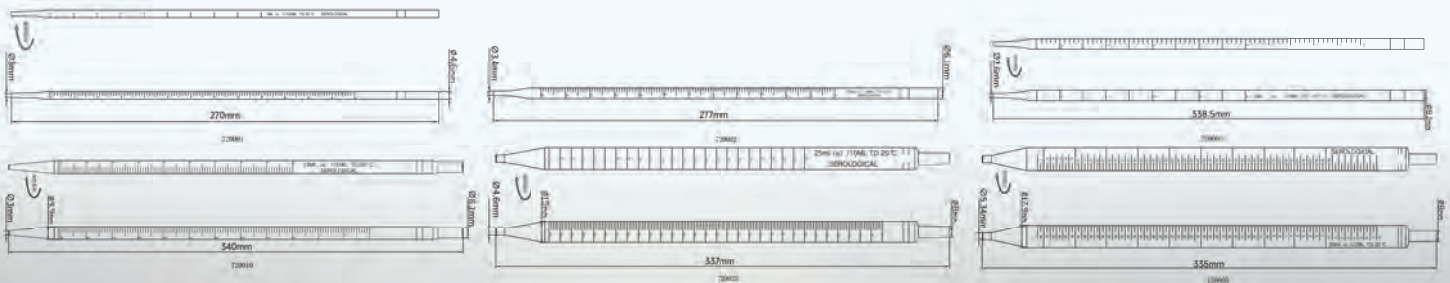

Dimensions=mm



# Cell Strainer

## Product Feature

- Imported nylon screen
- Size options : 40μm, 70μm and 100μm
- Artificial mechanical design, round handle, easy to operate
- Fit 50ml centrifuge tube
- DNase & RNase free ,non-endotoxin
- Individually packaged, E- beam sterilized



Order No.	Mesh aperture	Color	Sterile	Non-enzyme	Style	Packing
700040	40μm	Blue	Yes	Yes	Individual	100pcs/case
700070	70μm	White	Yes	Yes	Individual	100pcs/case
700100	100μm	Yellow	Yes	Yes	Individual	100pcs/case

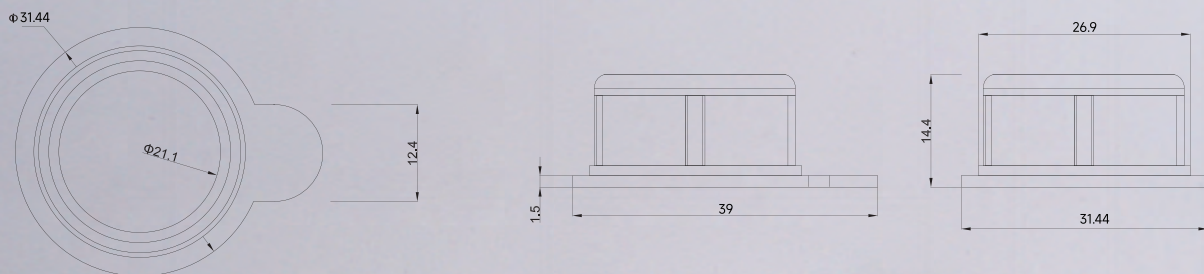

Dimensions=mm



# Cell Culture Dishes

Dimensions=mm

## Product Feature

- High transparency polystyrene material
- Bottom surface is flat and transparent, and will not emit light and distort under the microscope
- Stack positioning ring, easy to stack
- Plate cover ventilation grille design to ensure gas exchange
- The culture surface was treated by vacuum plasma (TC), and the cell adhesion was good
- Electron beam sterilization, sterile packaging
- no pyrogens , no endotoxin

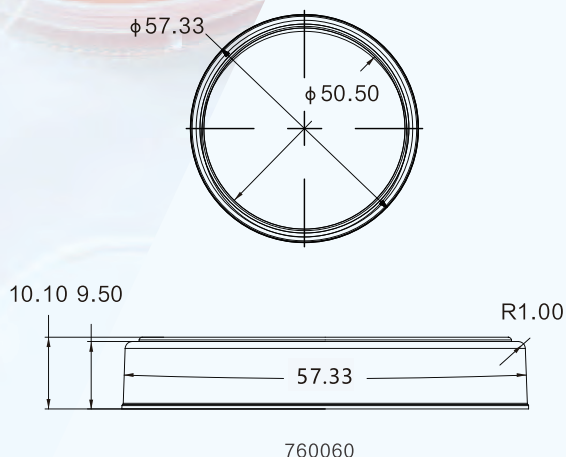

760060

Order No.	Size	TC Treated	Grip ring	Sterile	Non-enzyme	Packing
760035	35×10mm	Yes	without	No	Yes	20pcs/bag, 25bags/case
760060	60×15mm	Yes	without	No	Yes	20pcs/bag, 25bags/case
760100	100×20mm	Yes	without	No	Yes	10pcs/bag, 30bags/case
760035-1	35×10mm	Yes	With	Yes	Yes	20pcs/bag, 25bags/case
760060-1	60×15mm	Yes	With	Yes	Yes	20pcs/bag, 25bags/case
760100-1	100×20mm	Yes	With	Yes	Yes	10pcs/bag, 30bags/case
760150-1	150×20mm	Yes	With	Yes	Yes	5pcs/bag, 12bags/case
762035	35×10mm	No	With	Yes	Yes	10pcs/bag, 50bags/case
762060	60×15mm	No	With	Yes	Yes	10pcs/bag, 50bags/case
762100	100×20mm	No	With	Yes	Yes	10pcs/bag, 30bags/case
762150	150×20mm	No	With	Yes	Yes	5pcs/bag, 12bags/case

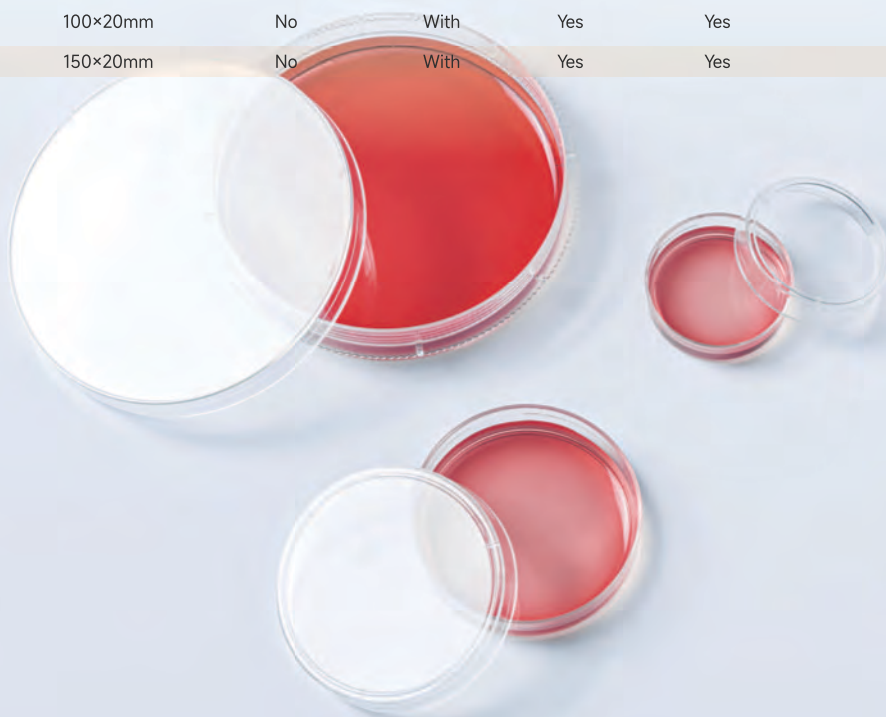



# Confocal Petri Dishes

## Product Feature

- High transparent PS material, easy to observe
- The plate cover and plate bottom are set with multiple card positions and slots to meet the diversity and convenience of the experiment
- Imported borosilicate glass bottom, the bottom surface is smooth and transparent, effectively avoid the depolarization of light
- E-beam sterilization, sterile packaging
- Non-endotoxin

Order No.	Hole Diameter	TC Treated	Sterile	Non-enzyme	Packing
763015	15mm	Yes	Yes	Yes	10pcs/bag, 20bags/case
763020	20mm	Yes	Yes	Yes	10pcs/bag, 20bags/case
763515	15mm	Yes	Yes	Yes	Blister individual packaging, 20pcs/box, 10boxes/case
763520	20mm	Yes	Yes	Yes	Blister individual packaging, 20pcs/box, 10boxes/case

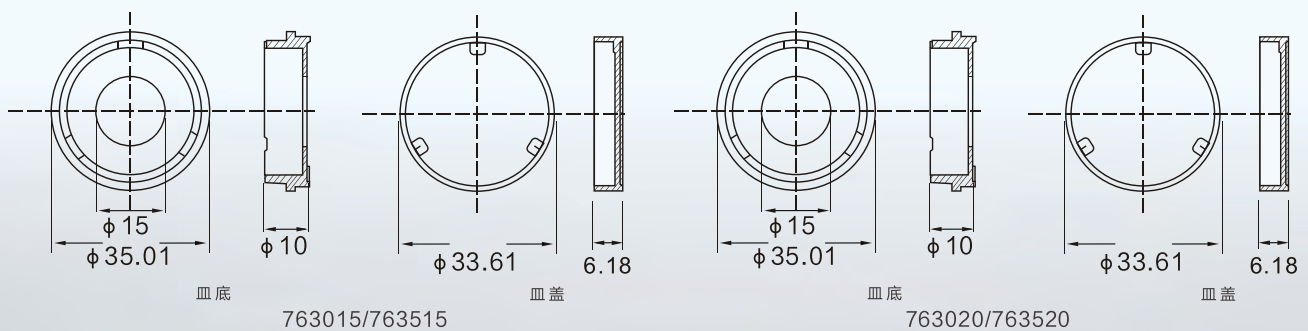

# Cell Culture Flasks

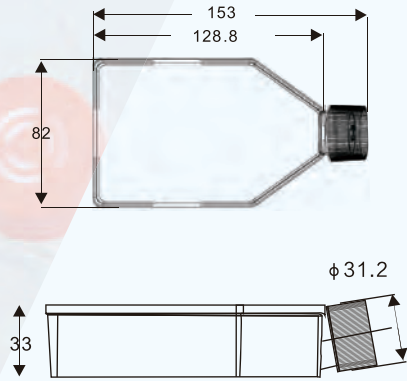

750075  
Dimensions=mm

## Product Feature

- high transparent PS material
- Bottle side matt surface, writing area, clear scale
- Stack design is not easy to slip, easy to stack
- E-beam sterilization
- Non-pyrogens ,non- endotoxin

Order No.	Culture area	Volume	Cover	TC Treated	Sterile	Non-enzyme	Packing
750025	25cm <sup>2</sup>	50ml	Breathable	Yes	Yes	Yes	12pcs/bag, 25bags/case
750075	75cm <sup>2</sup>	250ml	Breathable	Yes	Yes	Yes	5pcs/bag, 18bags/case
750175	175cm <sup>2</sup>	750ml	Breathable	Yes	Yes	Yes	5pcs/bag, 10bags/case
750225	225cm <sup>2</sup>	950ml	Breathable	Yes	Yes	Yes	5pcs/bag, 5bags/case
751025	25cm <sup>2</sup>	50ml	Breathable	Yes	Yes	Yes	10pcs/bag, 20bags/case
751075	75cm <sup>2</sup>	250ml	Breathable	Yes	Yes	Yes	5pcs/bag, 20bags/case
751175	175cm <sup>2</sup>	750ml	Breathable	Yes	Yes	Yes	5pcs/bag, 10bags/case
751225	225cm <sup>2</sup>	950ml	Breathable	Yes	Yes	Yes	5pcs/bag, 5bags/case
752025	25cm <sup>2</sup>	50ml	Sealed	No	Yes	Yes	10pcs/bag, 20bags/case
752075	75cm <sup>2</sup>	250ml	Sealed	No	Yes	Yes	5pcs/bag, 20bags/case
752175	175cm <sup>2</sup>	750ml	Sealed	No	Yes	Yes	5pcs/bag, 10bags/case
752225	225cm <sup>2</sup>	950ml	Sealed	No	Yes	Yes	5pcs/bag, 10bags/case
753025	25cm <sup>2</sup>	50ml	Sealed	No	Yes	Yes	10pcs/bag, 20bags/case
753075	75cm <sup>2</sup>	250ml	Sealed	No	Yes	Yes	5pcs/bag, 20bags/case
753175	175cm <sup>2</sup>	750ml	Sealed	No	Yes	Yes	5pcs/bag, 10bags/case
753225	225cm <sup>2</sup>	950ml	Sealed	No	Yes	Yes	5pcs/bag, 10bags/case

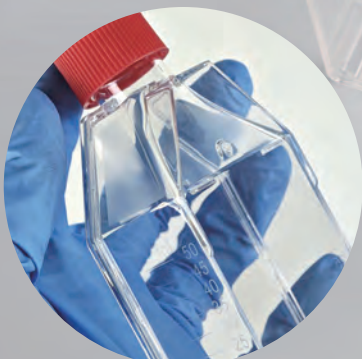

# Cell Culture Plates

## Product Feature

- High transparency PS material
- Cover cut Angle design with condensation ring reduces the chance of contamination
- Each hole is coded, easy to distinguish and identify
- No pyrogen, no endotoxin, DNase&RNase free
- E-beam sterilization

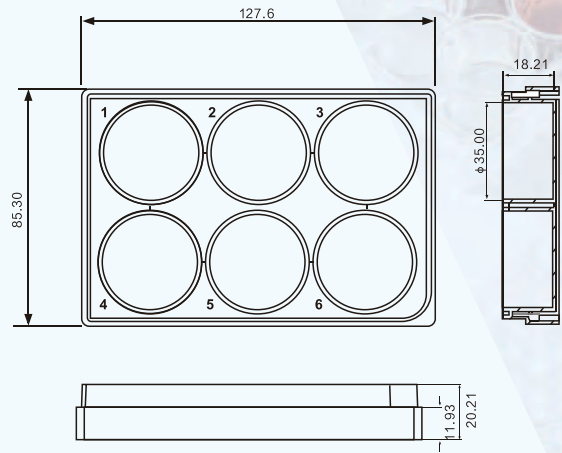

740006

Dimensions=mm

Order No.	Dimension	Seeding density	Growth medium (ml)	TC Treated	Sterile	Non-enzyme	Style	Packing
740006	6-well, 84.4x127.6mm	9.5cm <sup>2</sup>	1.9-2.9ml	Yes	Yes	Yes	Individual	50pcs/case
740012	12-well, 84.4x127.6mm	3.6cm <sup>2</sup>	0.76-1.14ml	Yes	Yes	Yes	Individual	50pcs/case
740024	24-well, 84.4x127.6mm	1.9cm <sup>2</sup>	0.38-0.57ml	Yes	Yes	Yes	Individual	50pcs/case
740048	48-well, 84.4x127.6mm	0.88cm <sup>2</sup>	0.19-0.285ml	Yes	Yes	Yes	Individual	50pcs/case
740096	96-well, 84.4x127.6mm	0.32cm <sup>2</sup>	0.1-0.2ml	Yes	Yes	Yes	Individual	50pcs/case
742006	6-well, 84.4x127.6mm	9.5cm <sup>2</sup>	1.9-2.9ml	No	Yes	Yes	Individual	50pcs/case
742012	12-well, 84.4x127.6mm	3.6cm <sup>2</sup>	0.76-1.14ml	No	Yes	Yes	Individual	50pcs/case
742024	24-well, 84.4x127.6mm	1.9cm <sup>2</sup>	0.38-0.57ml	No	Yes	Yes	Individual	50pcs/case
742048	48-well, 84.4x127.6mm	0.88cm <sup>2</sup>	0.19-0.285ml	No	Yes	Yes	Individual	50pcs/case
742096	96-well, 84.4x127.6mm	0.32cm <sup>2</sup>	0.1-0.2ml	No	Yes	Yes	Individual	50pcs/case

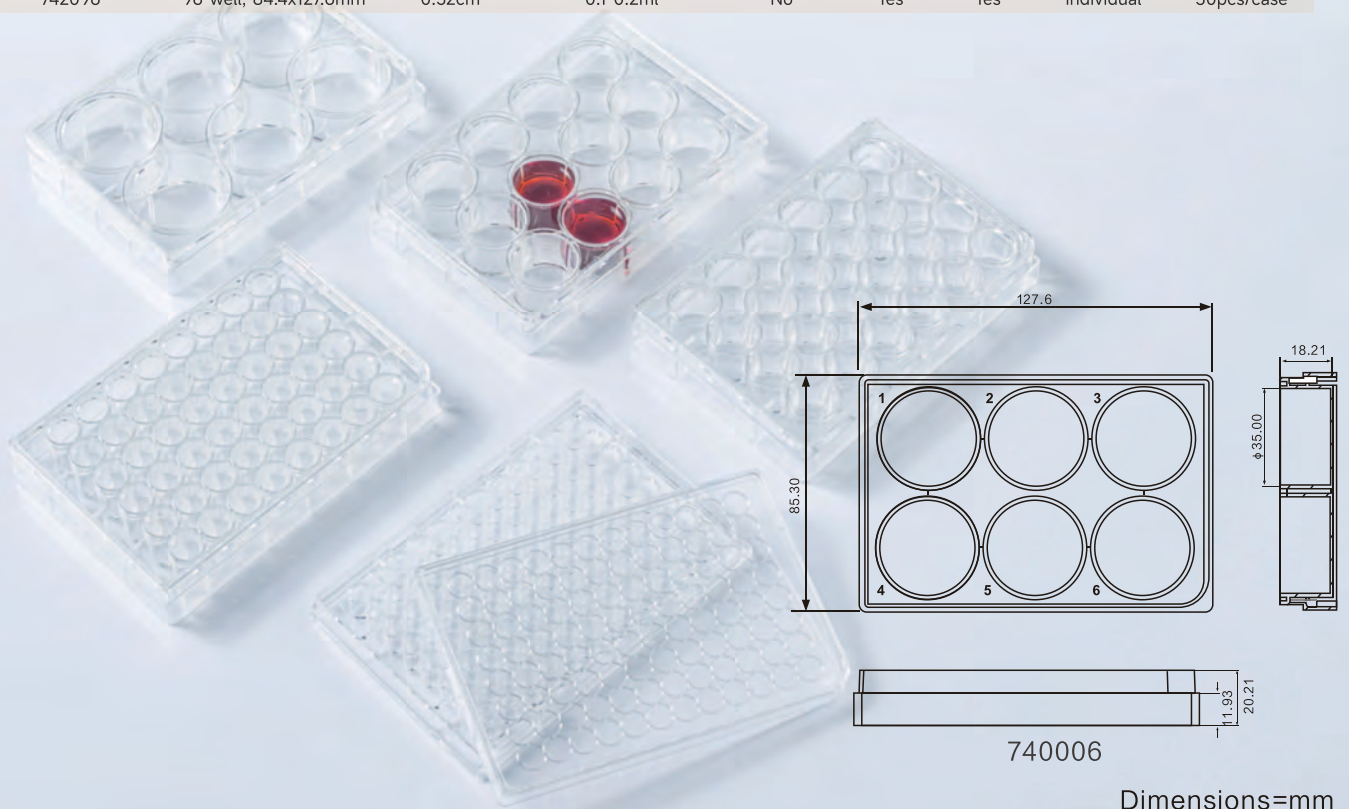

740006

Dimensions=mm



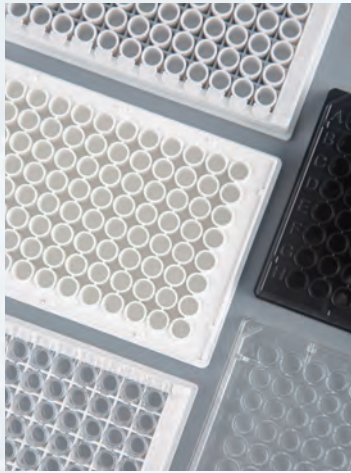

# ELISA Plate

## Product Feature

- Medical grade polystyrene material
- Removable for use in ELISA experiments
- In accordance with ANSI-SBS standard, CV value between holes <5%
- No DNase, RNase, no endotoxin
- Transparent plate: Suitable for quantitative and qualitative solid-phase immunoassay and combination assay
- White plate: suitable for self-luminescence, chemiluminescence
- Black plate: Suitable for fluorescence immunoassay and combination assay

Order No.	Volume	Color	Type	Sterile	Binding	Packing
770001	0.3ml	Transparent	Non-detachable Medium	No	Middle	10pcs/bag, 20bags/case
770010	0.3ml	Transparent	Non-detachable High	No	High	10pcs/bag, 20bags/case
770002	0.3ml	White	Non-detachable Medium	No	Middle	10pcs/bag, 20bags/case
770020	0.3ml	White	Non-detachable High	No	High	10pcs/bag, 20bags/case
770003	0.3ml	Black	Non-detachable Medium	No	Middle	10pcs/bag, 20bags/case
770030	0.3ml	Black	Non-detachable High	No	High	10pcs/bag, 20bags/case
772001	0.4ml	Transparent	F8*12	No	High	10pcs/bag, 20bags/case





# BIOBANK CONSUMABLES SOLUTIONS

Biobank is one of the three main businesses of AMNGENT. Positioning on the two development factors of standardization and informatization, AMNGENT provides customers with systematic consumables solutions from the aspects of clinical collection, sample processing, sample storage and achievement transformation of biobank.

## Cryogenic vials - quality concept

To avoid exposing cell samples and their components to additional risks of contamination with disruptive substances during vital preservation<sup>1</sup> in Cryogenic tubes, all tubes have undergone a number of tests.

Having passed these defined test procedures, the Cryogenic tubes have been certified as follows:

- ✓ **Sterile**
- ✓ **Pyrogen-free/endotoxin-free**
- ✓ **Non-cytotoxic**
- ✓ **CE**

We guarantee that the following limits will not be exceeded:

- ▶ **Sterility validated according to the ISO 11137 series of standards**
- ▶ **Pyrogens/endotoxins < 0.01 EU/tube**
- ▶ **Non-cytotoxic in accordance with the ISO 10993 series of standards**





# Traditional Cryogenic Vials

## Product Feature

- Medical grade PP material: USP Biological Reactivity test report ,USP Plastic Class VI grade
- Non-Cytotoxicity
- RNase & Dnase free
- Pyrogen /Endotoxin free
- Heavy metal-free
- Sterile
- Standard 100,000 clean workshop production
- Temperature range: -196 to 121 °C (-320 to 250 °F)
- **CE**

\*Above mentioned can provide third-party reports or associated product reports





- 0.5ml、1.0ml、1.5ml、2.0ml、5.0ml more volumes ok for options
- Ultra-transparent Cryo tubes are available with secure external thread and a volume of 0.5 to 5 ml to reduce the risk of contamination  
For increased storage density (10 x 10 grid), a 2 ml Cryo tube with internal thread and silicone seal is available
- Cap color: white, red, yellow, blue, green, orange, purple for options
- Cap style :Flat , automatic cap, Higher cap, colour-coded inserts cap  
Automatic cap:suitable for decapper/recapper  
Flat cap&high cap & colour-coded insert cap: easy for label and writing record  
High cap : easy take from cryoboxes
- Cap new technical , match with tube smooth and easy, Screw cap without damping



- Cap bottom design : easy for lock and one hand operation
- Tube two-tone printing: UV printing, Black scale mark+ white writing area, Clearly identify  
White writing area suitable for watercolor pen, Mark pen, White-board writing, clearly and tidy
- Scale range : within  $\pm 0.1$
- Sealing : under  $-90\text{Kpa}$  ,15mins testing.  $40^{\circ}\text{C}$  constant temperature test .  
Test reports are available
- Temperature range:  $-196$  to  $121^{\circ}\text{C}$  ( $-320$  to  $250^{\circ}\text{F}$ )





Item No.	Volume	Volume	Type	Cap Style	Sterile	Packaging Specifications
66005X[X=0,1,2,3,4,5,6]	0.5ml	White/red/green/blue/yellow/purple/orange	External Thread	Flat cap	Yes	50pcs/bag, 20bags/carton
66010X[X=0,1,2,3,4,5,6]	1.0ml	White/red/green/blue/yellow/purple/orange	External Thread	Flat cap	Yes	50pcs/bag, 20bags/carton
66015X[X=0,1,2,3,4,5,6]	1.5ml	White/red/green/blue/yellow/purple/orange	External Thread	Flat cap	Yes	50pcs/bag, 20bags/carton
66120X[X=0,1,2,3,4,5,6]	2.0ml	White/red/green/blue/yellow/purple/orange	External Thread	No insert	Yes	50pcs/bag, 20bags/carton
66220X[X=0,1,2,3,4,5,6]	2.0ml	White/red/green/blue/yellow/purple/orange	External Thread	Flat cap	Yes	50pcs/bag, 20bags/carton
66121X[X=0,1,2,3,4,5,6]	2.0ml	White/red/green/blue/yellow/purple/orange	Internal Thread	No insert	Yes	50pcs/bag, 20bags/carton
66221X[X=0,1,2,3,4,5,6]	2.0ml	White/red/green/blue/yellow/purple/orange	Internal Thread	insert	Yes	50pcs/bag, 20bags/carton
66050X[X=0,1,2,3,4,5,6]	5.0ml	White/red/green/blue/yellow/purple/orange	External Thread	Automatic cap	Yes	50pcs/bag, 20bags/carton
66000Xcap plug series[X=0,1,2,3,4,5]	fitted2.0ml	White/red/green/blue/yellow/purple	fitted with internal cap	—	Yes	200pcs/bag, 10bags/carton

## Dimension

Unit: mm

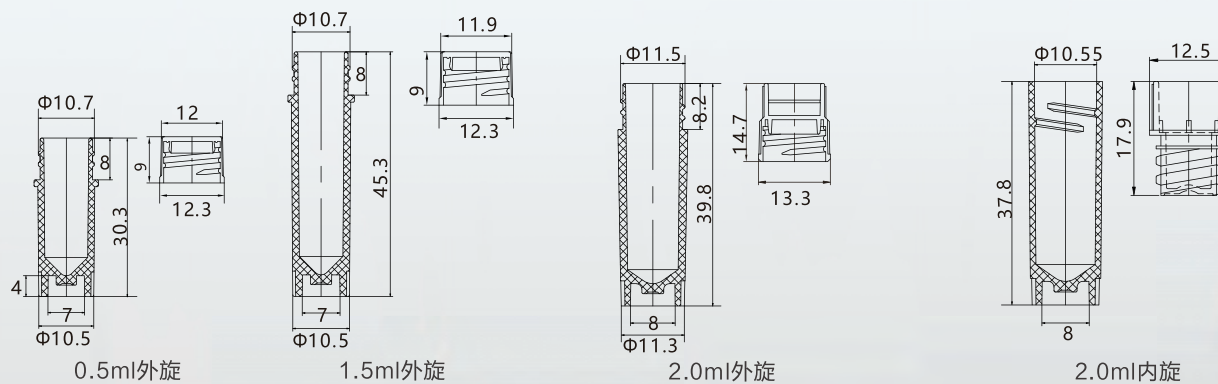

# 2D Cryogenic Vials

## Product Feature

- Bottom QR code, tube side barcode and Number
- Laser etched 2D barcodes
- Scan time within 3sec 100pcs/rack
- 0.5ml 1.5ml 2.0ml suitable for 10\*10 cryoboxes  
5.0ml suitable for 9\*9 cryoboxes For increased storage density





Item No.	Volume	Color	Type	Side barcode	Bottom or Code	Sterile & Non-enzyme	Packaging Specifications
67005X[X=0,1,2,3,4,5,6]	0.5ml	White/red/green/blue/yellow/purple/orange	External Thread	Yes	No	Yes	50pcs/bag, 20bags/carton
67010X[X=0,1,2,3,4,5,6]	1.0ml	White/red/green/blue/yellow/purple/orange	External Thread	Yes	No	Yes	50pcs/bag, 20bags/carton
67015X[X=0,1,2,3,4,5,6]	1.5ml	White/red/green/blue/yellow/purple/orange	External Thread	Yes	No	Yes	50pcs/bag, 20bags/carton
67120X[X=0,1,2,3,4,5,6]	2.0ml	White/red/green/blue/yellow/purple/orange	External Thread	Yes	No	Yes	50pcs/bag, 20bags/carton
67220X[X=0,1,2,3,4,5,6]	2.0ml	White/red/green/blue/yellow/purple/orange	External Thread Flat cap	Yes	No	Yes	50pcs/bag, 20bags/carton
67121X[X=0,1,2,3,4,5,6]	2.0ml	White/red/green/blue/yellow/purple/orange	Internal thread	Yes	No	Yes	50pcs/bag, 20bags/carton
67221X[X=0,1,2,3,4,5,6]	2.0ml	White/red/green/blue/yellow/purple/orange	Internal Thread with cap plug	Yes	No	Yes	50pcs/bag, 20bags/carton
67050X[X=0,1,2,3,4,5,6]	5.0ml	White/red/green/blue/yellow/purple/orange	External Thread	Yes	No	Yes	50pcs/bag,5bags/inner box,4inner boxes/carton
67605X[X=0,1,2,3,4,5,6]	0.5ml	White/red/green/blue/yellow/purple/orange	External Thread	Yes	Yes	Yes	50pcs/bag,10bags/inner box,2inner boxes/carton
67610X[X=0,1,2,3,4,5,6]	1.0ml	White/red/green/blue/yellow/purple/orange	External Thread	Yes	Yes	Yes	50pcs/bag,10bags/inner box,2inner boxes/carton
67615X[X=0,1,2,3,4,5,6]	1.5ml	White/red/green/blue/yellow/purple/orange	External Thread	Yes	Yes	Yes	50pcs/bag,10bags/inner box,2inner boxes/carton
67620X[X=0,1,2,3,4,5,6]	2.0ml	White/red/green/blue/yellow/purple/orange	External Thread	Yes	Yes	Yes	50pcs/bag,10bags/inner box,2inner boxes/carton
67621X[X=0,1,2,3,4,5,6]	2.0ml	White/red/green/blue/yellow/purple/orange	Internal Thread	Yes	Yes	Yes	50pcs/bag,10bags/inner box,2inner boxes/carton
67622X[X=0,1,2,3,4,5,6]	2.0ml	White/red/green/blue/yellow/purple/orange	Internal Thread with cap plug	Yes	Yes	Yes	50pcs/bag,10bags/inner box,2inner boxes/carton
67850X[X=0,1,2,3,4,5,6]	5.0ml	White/red/green/blue/yellow/purple/orange	External Thread automatic cap	Yes	Yes	Yes	50pcs/bag,5bags/inner box,4inner boxes/carton
68005X[X=0,1,2,3,4,5,6]	0.5ml	White/red/green/blue/yellow/purple/orange	External Thread	Yes	Yes	Yes	100pcs/rack,5racks/inner box,10inner boxes/carton
68010X[X=0,1,2,3,4,5,6]	1.0ml	White/red/green/blue/yellow/purple/orange	External Thread	Yes	Yes	Yes	100pcs/rack,5racks/inner box,10inner boxes/carton
68015X[X=0,1,2,3,4,5,6]	1.5ml	White/red/green/blue/yellow/purple/orange	External Thread	Yes	Yes	Yes	100pcs/rack,5racks/inner box,10inner boxes/carton
68121X[X=0,1,2,3,4,5,6]	2.0ml	White/red/green/blue/yellow/purple/orange	Internal Thread	Yes	Yes	Yes	100pcs/rack,5racks/inner box,10inner boxes/carton
68221X[X=0,1,2,3,4,5,6]	2.0ml	White/red/green/blue/yellow/purple/orange	Internal Thread with cap plug	Yes	Yes	Yes	100pcs/rack,5racks/inner box,10inner boxes/carton
68120X[X=0,1,2,3,4,5,6]	2.0ml	White/red/green/blue/yellow/purple/orange	Internal Thread	Yes	Yes	Yes	100pcs/rack,5racks/inner box,10inner boxes/carton
68850X[X=0,1,2,3,4,5,6]	5.0ml	White/red/green/blue/yellow/purple/orange	External Thread automatic cap	Yes	Yes	Yes	81pcs/rack,5racks/inner box,10inner boxes/carton



# 2D Automatic Cap Cryogenic Vials

## Product Feature

- Upgrade to automatic cap from normal screw cap
- Suitable: Auto Pipetting workstation, Automatic pipette tips, ultra-low temperature freezer
- Suitable : Hold the lid decapper, full plate decapper, achieve automatic high throughput switch cover



Item No.	Volume	Color	Type	Side barcode	Bottom or Code	Sterile & Non-enzyme	Packaging Specifications
67805X[X=0,1,2,3,4,5,6]	0.5ml	White/red/green/blue/yellow/purple/orange	External Thread automatic cap	Yes	Yes	Yes	50pcs/bag,10bags/inner box,2inner boxes/carton
67815X[X=0,1,2,3,4,5,6]	1.5ml	White/red/green/blue/yellow/purple/orange	External Thread automatic cap	Yes	Yes	Yes	50pcs/bag,10bags/inner box,2inner boxes/carton
67820X[X=0,1,2,3,4,5,6]	2.0ml	White/red/green/blue/yellow/purple/orange	External Thread automatic cap	Yes	Yes	Yes	50pcs/bag,10bags/inner box,2inner boxes/carton
67850X[X=0,1,2,3,4,5,6]	5.0ml	White/red/green/blue/yellow/purple/orange	External Thread automatic cap	Yes	Yes	Yes	50pcs/bag,5bags/inner box,4inner boxes/carton
68805X[X=0,1,2,3,4,5,6]	0.5ml	White/red/green/blue/yellow/purple/orange	External Thread automatic cap	Yes	Yes	Yes	100pcs/rack,5racks/inner box,10inner boxes/carton
68815X[X=0,1,2,3,4,5,6]	1.5ml	White/red/green/blue/yellow/purple/orange	External Thread automatic cap	Yes	Yes	Yes	100pcs/rack,5racks/inner box,10inner boxes/carton
68820X[X=0,1,2,3,4,5,6]	2.0ml	White/red/green/blue/yellow/purple/orange	External Thread automatic cap	Yes	Yes	Yes	100pcs/rack,5racks/inner box,10inner boxes/carton
68850X[X=0,1,2,3,4,5,6]	5.0ml	White/red/green/blue/yellow/purple/orange	External Thread automatic cap	Yes	Yes	Yes	81pcs/rack,5racks/inner box,10inner boxes/carton



# SBS Cryogenic Vials

## Product Feature

- Medical grade PP material: USP Biological Reactivity test report ,USP Plastic Class VI grade
- Non-Cytotoxicity
- RNase & Dnase free
- Pyrogen /Endotoxin free
- Heavy metal-free
- Sterile
- Standard 100,000 clean workshop production
- Temperature range: -196 to 121 °C (-320 to 250 °F)
- **CE**

\*Above mentioned can provide third-party reports or associated product reports

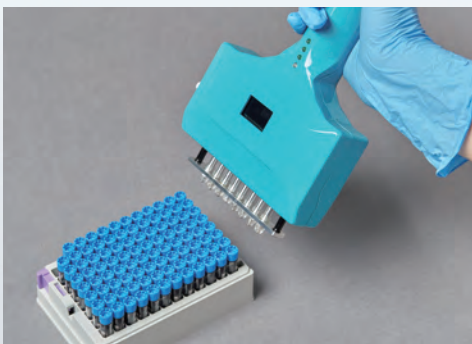

## AMNGENT new SBS offers you the possibility to save between 35% and 50% of your freezer space

- 0.5ml, 1.0ml, 1.5ml, 2.0ml more size for options
- Scan 3second 96pcs/rack
- Automatic cap suitable for Single channel, multi channel decapper/recapper
- 2D Data-Matrix coded on tube. barcodes on the side of SBS format racks, Ensure the sample is safe and traceable, Laser etched 2D barcodes, resistant to DMSO and other organic solvents
- Rack format: 0.5ml,0.75ml,1.0ml 96well format  
2.0ml 48well format
- Latch lock design,safety shipping
- Lid ok 90°right angle place on the rack.

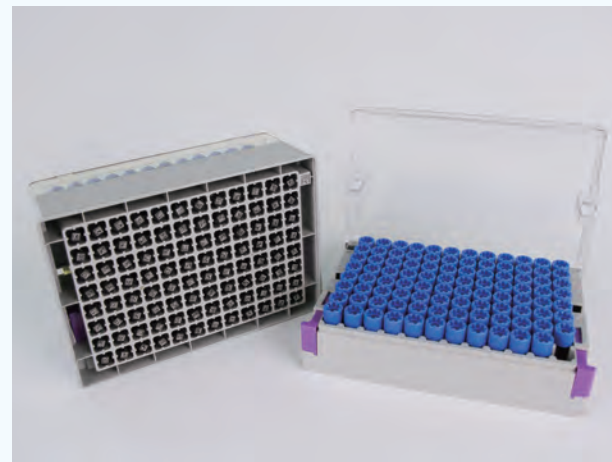
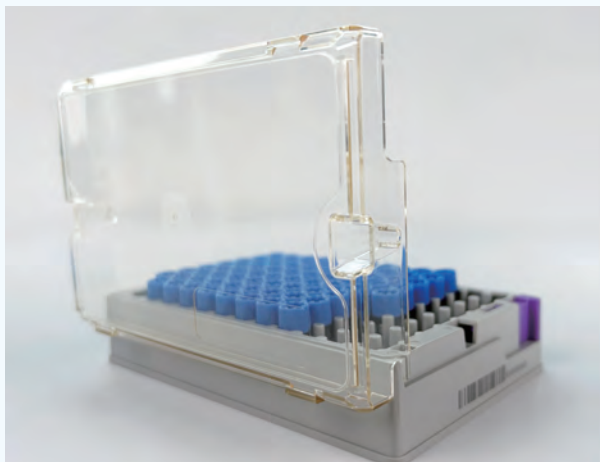

Item No.	Volume	Style	Type	3-in-1	Sterile & Non-enzyme	Packaging Specifications
674500	0.5ml	Bag Pack	External Thread	Yes	Yes	96pcs/bag,20bag/carton
674750	0.75ml	Bag Pack	External Thread	Yes	Yes	96pcs/bag,20bag/carton
674101	1.0ml	Bag Pack	External Thread	Yes	Yes	96pcs/bag,20bag/carton
674201	2.0ml	Bag Pack	External Thread	Yes	Yes	48pcs/bag,20bag/carton
684500	0.5ml	SBS tube+SBS rack	External Thread	Yes	Yes	96pcs/rack, 10racks/inner box,20racks/Carton
684750	0.75ml	SBS tube+SBS rack	External Thread	Yes	Yes	96pcs/rack, 10racks/inner box,20racks/Carton
684101	1.0ml	SBS tube+SBS rack	External Thread	Yes	Yes	96pcs/rack, 10racks/inner box,20racks/Carton
684201	2.0ml	SBS tube+SBS rack	External Thread	Yes	Yes	48pcs/rack, 10racks/inner box,20racks/Carton



# Cardboard Cryo boxes

## Product Feature

- Two sides super white & strong cardboard material
- Waterproof coating, white glossy and color matte film for options
- Available in Various material insert or divider
- Available in different heights
- 2inch Cryoboxes suitable for 1.5ml & 2.0ml cryogenic tube.
- Temperature range: -196 to 121 °C (-320 to 250 °F), Used for liquid nitrogen preservation after punching

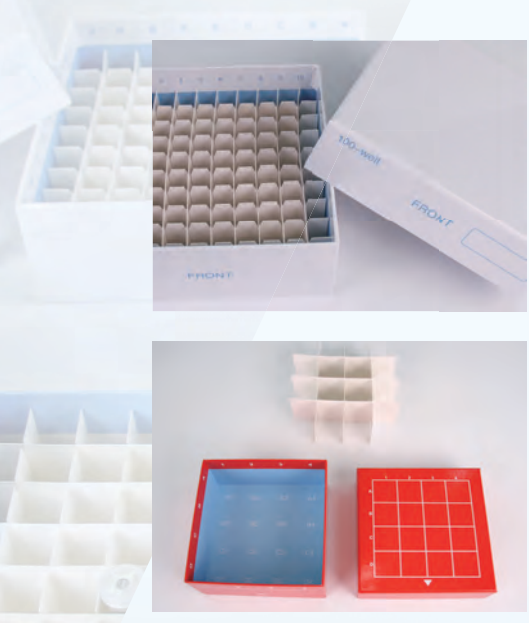

Item No.	Height	Well	Well	Color	Film Style	Packaging Specifications
810281	2 Inch	81-well	133*133*52mm	81-well	White Glossy Film	5pcs/pack, 10packs/carton
810200	2 Inch	100-well	133*133*52mm	100-well	White Glossy Film	5pcs/pack, 10packs/carton
810316	2 Inch	16-well	133*133*62mm	16-well	Red Glossy Film	4pcs/pack, 10packs/carton
810249	2 Inch	49-well	133*133*42mm	49-well	Blue Glossy Film	6pcs/pack, 10packs/carton

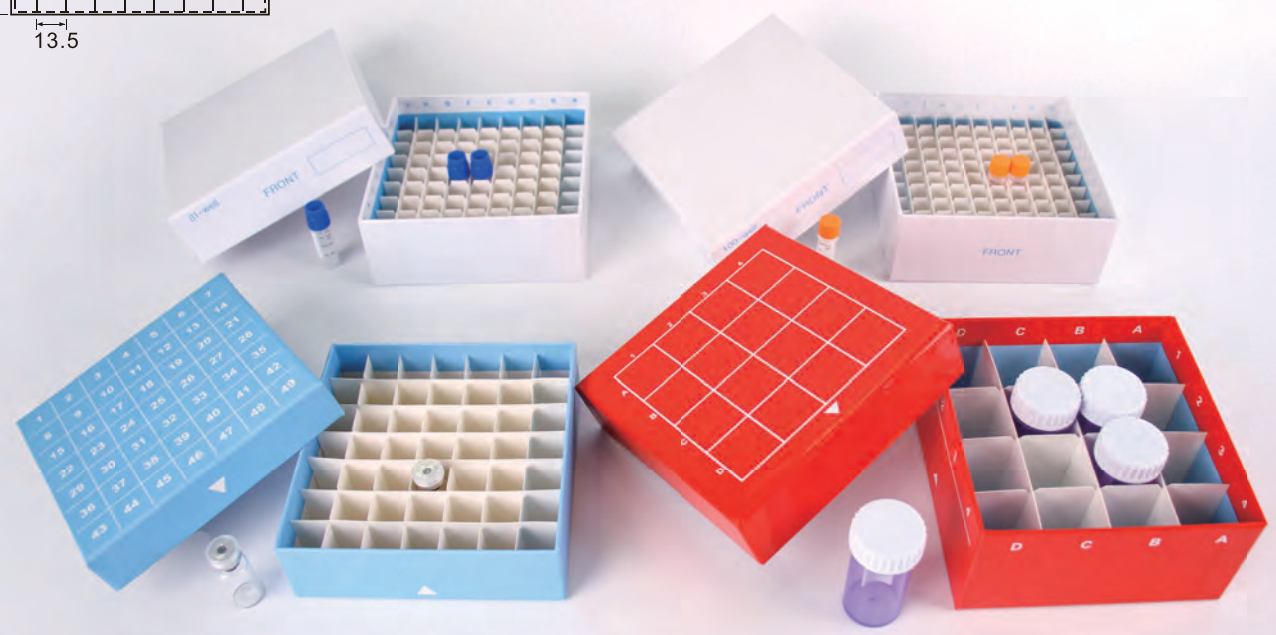
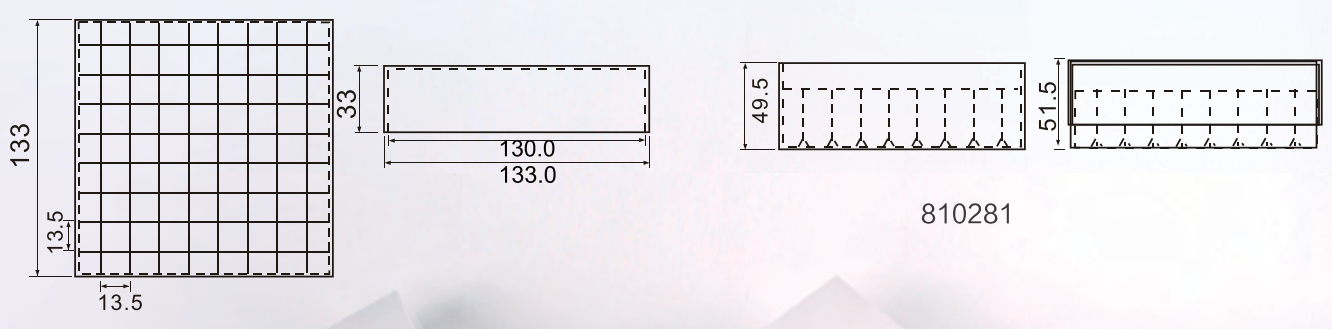

# Hinged lid Cardboard Cryoboxes / Rivet Cryoboxes

## Product Feature

- Waterproof coating, both sides, plastic divider
- Plastic PP divider
- Lid, bottom,side all have numbers for record,Convenience sample location
- Hinged lid design easy for storage,in case lid lost
- Available in different heights 1inch 100well ,2inch 100well & 81well,3.75inch 81well ,Customization
- Suitable for 0.5ml、1.0ml、1.5ml、2.0ml、5.0ml tubes or 1.5ml、2.0ml micro centrifuge tubes、15ml 、50ml centrifuge tubes
- Liquid nitrogen special glue, can achieve long-term use in liquid nitrogen environment
- 133\*133mm standard size, suitable for different size freezer rack
- Temperature range: -196 to 121 °C (-320 to 250 °F), Used for liquid nitrogen preservation after punching



Item No.	Height	Well	Size	Rivet	Block Material	Packaging Specifications
820100	1 Inch	100-well	133*133*36mm	No	PP	8pcs/pack, 10packs/carton
820281	2 Inch	81-well	133*133*52mm	No	PP	5pcs/pack, 10packs/carton
820200	2 Inch	100-well	133*133*52mm	No	PP	5pcs/pack, 10packs/carton
820381	3.75 Inch	81-well	133*133*95mm	No	PP	3pcs/pack, 10packs/carton
830100	1 Inch	100-well	133*133*36mm	Yes	PP	5pcs/pack, 10packs/carton
830281	2 Inch	81-well	133*133*52mm	Yes	PP	5pcs/pack, 10packs/carton
830200	2 Inch	100-well	133*133*52mm	Yes	PP	5pcs/pack, 10packs/carton

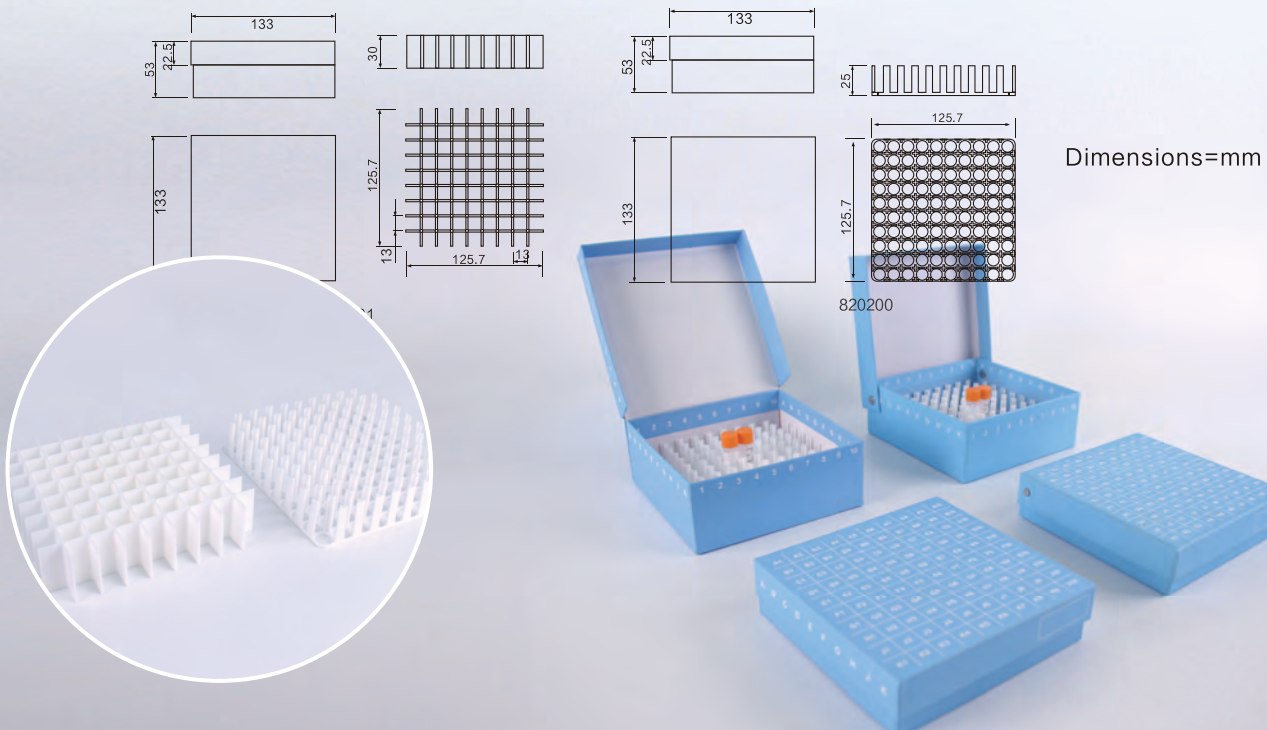



# PP Cryo boxes

## Product Feature

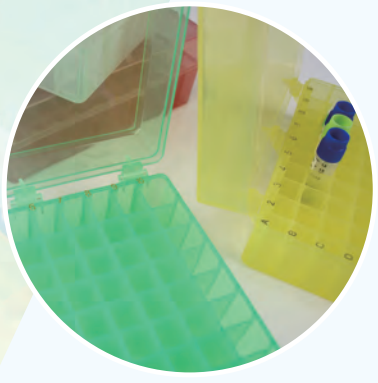

- Medical Grade PP Material, USP Biological Reactivity test report , chemically resistant to alcohols and mild organic solvents
- Five assorted colors available
- Numbered grids for sample identification
- Can be repeatedly frozen
- 9x9 (81-well) ,10x10 (100-well)hinged and top and bottom for options
- 81-well & 100-well hinged lid Compatible with 1.5ml & 2.0ml micro-tubes and cryogenic vials. 100-well top and bottom shape suitable for 1.5ml microtubes and cryogenic vials
- Drain holes and air vents minimize condensation
- 133\*133mm standard size, suitable for different size freezer rack
- Working temperature: stable from -86°C to 121°C(-187 to 250 °F)

Item No.	Height	Well	Size	Color	Packaging Specifications
821281	2 Inch	81-well	132*132*52mm	Assorted Color	5pcs/pack,4packs/carton
821281-W/R/B/Y/G	2 Inch	81-well	132*132*52mm	Transparent White/red/blue/yellow/green	5pcs/pack,4packs/carton
821200	2 Inch	100-well	132*132*53mm	Assorted Color	5pcs/pack,4packs/carton
821200-W/R/B/Y/G	2 Inch	100-well	132*132*53mm	Transparent White/red/blue/yellow/green	5pcs/pack,4packs/carton
821201	2 Inch	100-well	140*154*53mm	Assorted Color	5pcs/pack,4packs/carton
821201-W/R/B/Y/G	2 Inch	100-well	140*154*53mm	Transparent White/red/blue/yellow/green	5pcs/pack,4packs/carton

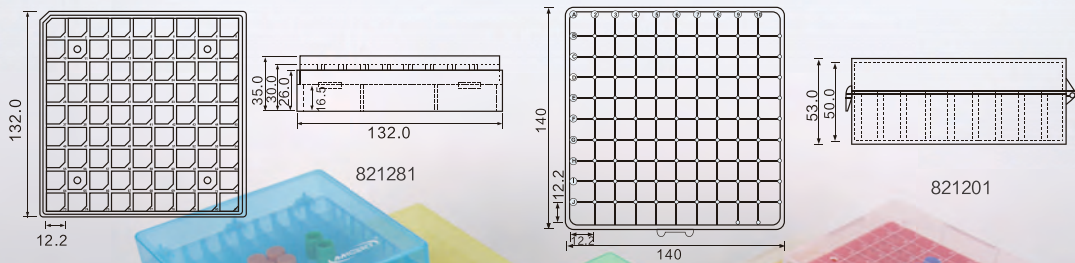

Dimensions=mm

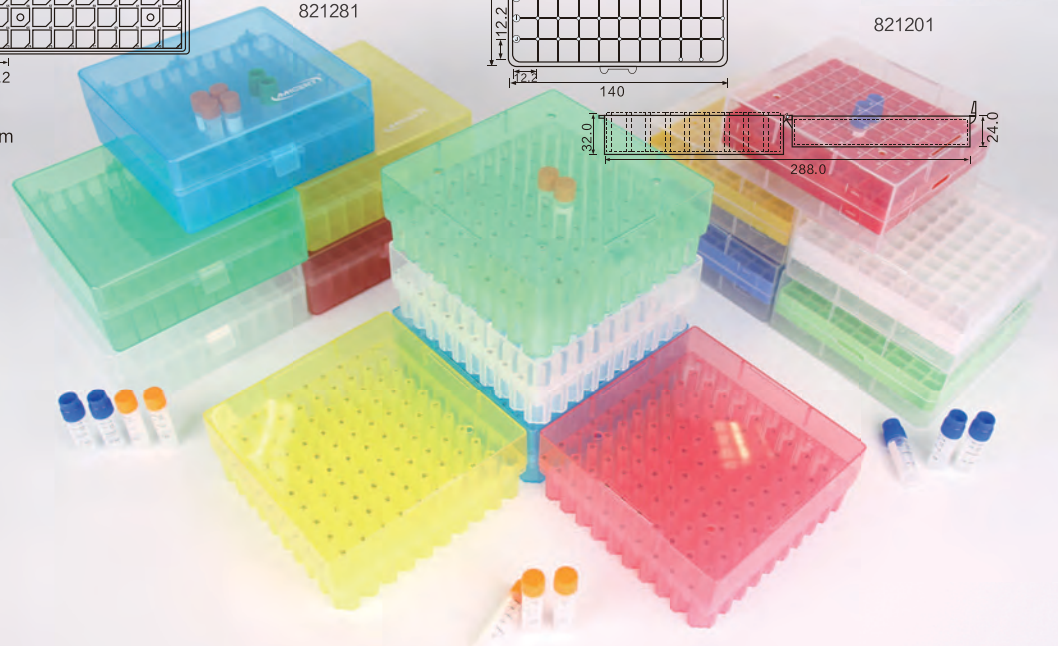



# PC Cryoboxes

## Product Feature

- Made with PC material. Durable, all-plastic storage box for short- or long-term storage
- Boxes are stackable. Designed for 5x5 (25well), 9x9 (81well), or 10x10 (100well) places to store both internal and external threaded vials (0.5ml - 5 ml).
- Printed grid on plastic lids for easy inventory management
- Fast and exact place corner cut design
- Available in a variety of color options. red, blue, green, white, and yellow
- Working Temperature range: -196 to 121 °C (-320 to 250 °F), Used for Ultra-low temperature freezer and liquid nitrogen environment

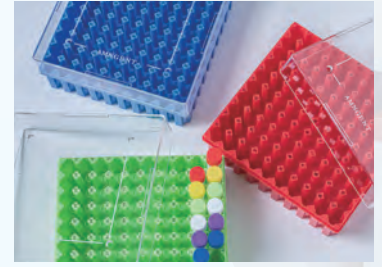

Item No.	Height	Well	Size	Color	Packaging Specifications
822225	2 Inch	25-well	73*73*52mm	Orange	5pcs/pack, 6packs/carton
822281	2 Inch	81-well	132*132*53mm	Assorted Color	5pcs/pack, 4packs/carton
822281-W/R/B/Y/G	2 Inch	81-well	132*132*53mm	White/red/blue/yellow/green	5pcs/pack, 4packs/carton
822200	2 Inch	100-well	132*132*53mm	Assorted Color	5pcs/pack, 4packs/carton
822200-W/R/B/Y/G	2 Inch	100-well	132*132*53mm	White/red/blue/yellow/green	5pcs/pack, 4packs/carton
822381	3.75Inch	81-well	133*133*96mm	Assorted Color	5pcs/pack, 4packs/carton
822381-W/R/B/Y/G	3.75Inch	81-well	133*133*96mm	White/red/blue/yellow/green	5pcs/pack, 4packs/carton
861100	1Inch	100-well	132*132*36mm	Orange	5pcs/pack, 4packs/carton
861150	2 Inch	100-well	132*132*53mm	Orange	5pcs/pack, 4packs/carton
861200	2 Inch	100-well	136*136*53mm	Orange	5pcs/pack, 4packs/carton
861500	3.75Inch	81-well	133*133*96mm	Orange	5pcs/pack, 4packs/carton



# Cell Freezing Container for 12 x 1ml or 2ml Cryo Tubes

## Product Feature

- Alcohol-free Cell Freezing Containers for 12 x 1ml or 2ml Cryo Tubes ensure controlled-rate  $-1^{\circ}\text{C}/\text{minute}$  cell freezing in a  $-80^{\circ}\text{C}$  freezer.
- No alcohol or fluids required
- Consistent heat removal through freezing period.
- Unbreakable, easy and safe to open when frozen
- For use with stem cells, primary cells and cell lines
- Suitable for 1.0ml .15ml 2.0ml cryogenic tubes

Item No.	Volume	Match	Packaging Specifications
900112	12pcs	1.0ml, 1.5ml, 2.0ml cryogenic vials	1pcs/carton



## Frame Freezer Racks

- Flanging treatment, no risk of scratching.
- Replaceable color tag, it can be identified in frost conditions.
- OEM size and shape available for the customer required
- Made of imported stainless steel, resistant to high and low temperatures, and acid and alkali resistant. The thickness of the steel plate is 0.4mm-0.5mm, and the top layer of the refrigerator is easy to take.



Item No.	Material	Size(D*W*H)	Thickness	Storage capacity	Match the size with cryobox
701212	Stainless steel	422*137*229mm	0.4mm-0.5mm	3*4	133*133*52mm
701215	Stainless steel	422*137*284mm	0.4mm-0.5mm	3*5	133*133*52mm
701216	Stainless steel	560*137*229mm	0.4mm-0.5mm	4*4	133*133*52mm
701220	Stainless steel	560*137*284mm	0.4mm-0.5mm	4*5	133*133*52mm
701224	Stainless steel	560*137*339mm	0.4mm-0.5mm	4*6	133*133*52mm
701225	Stainless steel	696*137*284mm	0.4mm-0.5mm	5*5	133*133*52mm

## Sliding Drawer Freezer Racks

- Fold-over guide rail to reduce frost, the whole plate is stamped and formed.
- Replaceable color tag, can be identified in frost conditions.
- Made of imported stainless steel, resistant to high and low temperatures, acid and alkali.
- The thickness of the steel plate is 0.5mm-1.0mm, which is strong and durable.
- The design of the guide rail solves the problem of frosting on the shelf of the freezing rack.
- OEM ok offer : size and shape available for the customer required



Item No.	Material	Size(D*W*H)	Thickness	Storage capacity	Match the size with cryobox
702212	Stainless Steel	420*141*229mm	0.4mm-0.5mm	3*4	133*133*52mm
702215	Stainless Steel	420*141*285mm	0.4mm-0.5mm	3*5	133*133*52mm
702216	Stainless Steel	564*141*229mm	0.4mm-0.5mm	4*4	133*133*52mm
702220	Stainless Steel	560*141*285mm	0.4mm-0.5mm	4*5	133*133*52mm
702224	Stainless Steel	560*141*341mm	0.4mm-0.5mm	4*6	133*133*52mm
702225	Stainless Steel	700*141*285mm	0.4mm-0.5mm	5*5	133*133*52mm

## Side Access Drawer Freezer Racks

- Electric welding, lightweight and convenient.
- Made of imported stainless steel, resistant to high and low temperatures, acid and alkali.
- The design of the guide rail solves the problem of frosting on the shelf of the freezing rack.
- The thickness of the steel plate is 0.5mm-1.0mm, which is strong and durable.
- Freezer racks can be customized according to the actual needs of users.

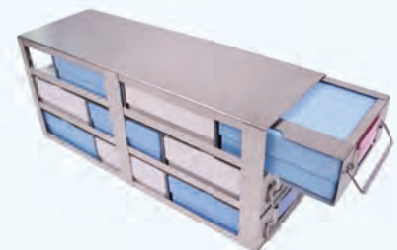

Item No.	Material	Size(D*W*H)	Thickness	Storage capacity	Match the size with cryobox
703212	Stainless Steel	420*141*229mm	0.6-1.2mm	3*4	133*133*52mm
703216	Stainless Steel	564*141*229mm	0.6-1.2mm	4*4	133*133*52mm
703220	Stainless Steel	564*141*285mm	0.6-1.2mm	4*5	133*133*52mm
703224	Stainless Steel	564*141*341mm	0.6-1.2mm	4*6	133*133*52mm
703225	Stainless Steel	700*141*285mm	0.6-1.2mm	5*5	133*133*52mm



## Horizontal Freezer Racks

- One punch forming, strong and durable.
- Made of imported stainless steel, resistant to high and low temperatures, acid and alkali.
- The thickness of the steel plate is 0.4mm-0.8mm, and it is easy to take.
- OEM ok offer : size and shape available for the customer required

Item No.	Material	Type	Size(D*W*H)	Storage capacity	Match The Size With Cryobox
704210	Stainless steel	Hand-carrying freezer rack	143*137*560mm	1*10	133*133*52mm
704211	Stainless steel	Hand-carrying freezer rack	143*137*616mm	1*11	133*133*52mm
704212	Stainless steel	Hand-carrying freezer rack	143*137*672mm	1*12	133*133*52mm
704213	Stainless steel	Hand-carrying freezer rack	143*137*728mm	1*13	133*133*52mm
704214	Stainless steel	Hand-carrying freezer rack	143*137*784mm	1*14	133*133*52mm
704215	Stainless steel	Hand-carrying freezer rack	143*137*840mm	1*15	133*133*52mm



## Self - Fixed Horizontal Freezing Rack

- Electric welding, lightweight and convenient.
- Made of imported stainless steel, resistant to high and low temperatures, acid and alkali.
- The design of the guide rail solves the problem of frosting on the shelf of the freezing rack.
- The thickness of the steel plate is 0.4mm-0.8mm, which is strong and durable.
- OEM ok offer : size and shape available for the customer required

Item No.	Material	Type	Size(D*W*H)	Storage capacity
735207	Stainless steel	Hand-carrying freezer rack	137*137*394mm	1*7
735208	Stainless steel	Hand-carrying freezer rack	137*137*450mm	1*8
735209	Stainless steel	Hand-carrying freezer rack	137*137*506mm	1*9
735210	Stainless steel	Hand-carrying freezer rack	137*137*562mm	1*10
735211	Stainless steel	Hand-carrying freezer rack	137*137*618mm	1*11
735212	Stainless steel	Hand-carrying freezer rack	137*137*674mm	1*12
735213	Stainless steel	Hand-carrying freezer rack	137*137*751mm	1*13
735214	Stainless steel	Hand-carrying freezer rack	137*137*808mm	1*14
735215	Stainless steel	Hand-carrying freezer rack	137*137*865mm	1*15
736207	Stainless steel	Hand-carrying freezer rack of SBS box	135*96*388mm	1*7
736213	Stainless steel	Hand-carrying freezer rack of SBS box	135*96*712mm	1*13
736214	Stainless steel	Hand-carrying freezer rack of SBS box	135*96*766mm	1*14
736215	Stainless steel	Hand-carrying freezer rack of SBS box	135*96*820mm	1*15

## Reader & Scanner

### Reader

- USB link, plug and play
- Both ok scan for Barcodes and QR codes
- Infrared technology, high-speed identification



### Third Generation Scanner

- Compatible with 133\*133mm cryogenic box & SBS scanner
- Reader time:  $\leq 1.5$  seconds.
- Plug and play, no software installation required.
- Anti fog treatment, To improve the recognition rate of cryogenic tubes after frosting
- Using HTTP service interface, it can be connected to any software database.







Description	Order No.	Design	Packaging Specifications
Reader	691101	single scan	1pcs/carton
Third Generation Scanner	692103	rack scan	1set/carton

## Semi-Automated Screw Cap Decapper/Recapper, Single Channel

### Product Feature

- 1 second fast Automatic column type open and close the cover
- Long battery standby time, standby time  $\geq 30$  days.
- Quiet type, the noise of recapper is  $\leq 5$  decibels.
- Customization for recapper gear, fit multiple brands of SBS cryovials



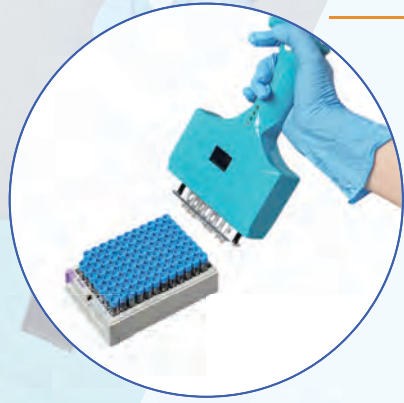

Order No.	Suitable for	Cap type	Packaging Specifications
696001	0.5ml、0.75ml、1.0ml SBS cryogenic vials		1pcs/carton
696002	0.5ml、1.5ml 2D Automatic Cryogenic vials		1pcs/carton
696003	2.0ml 2D Automatic Cryogenic vials		1pcs/carton
696004	2.0ml SBS cryogenic vials		1pcs/carton



## Semi-Automated Screw Cap Decapper/Recapper, Multichannel

### Product Feature

- 3 second fast Automatic column type open and close the cap
- Long battery standby time, standby time  $\geq 30$  days.
- Quiet type, the noise of recapper is  $\leq 5$  decibels.
- Customization for recapper gear, fit multiple brands of SBS cryovials.





Order No.	Channel	Suitable for	Cap style	Packaging Specifications
695005	5 channels	0.5ml, 1.5ml 2D Automatic Cryogenic vials		1pcs/carton
695006	6 channels	2.0ml SBS cryogenic vials		1pcs/carton
695008	8 channels	0.5ml, 0.75ml, 1.0ml SBS cryogenic vials		1pcs/carton

## SBS Screw Cap Decapper/Recapper, full plate

### Product Feature

- Integrate automated workflows.
- Independent motor system, real-time monitoring of torque and torsion.
- Compatible with SBS 48-well, 96-well plate rack and 133\*133mm plate rack.
- The full plate opening time is  $\leq 10$  seconds.



Order No.	Suitable for	Cap style	Packaging Specifications
695096	0.5ml, 0.75ml, 1ml, 2ml whole plate SBS cryotube	 	1set/carton
695100	0.5ml, 1.5ml, 2ml, 5ml 81 grid/100 grid whole box frozen storage tube	 	1set/carton



# Automated pipetting station

## Product Feature

- **Sample safety:** the sample does not need to leave the carrier frame after entering the system and does not disturb the layered interface; Pneumatic type  
Pipetting channel, low discharge function, minimize the possibility of aerosol contamination
- **Data security:** automatic barcode scanning, automatic entry of sample information; The whole process of sample processing data was recorded  
Record and store images of each sample to ensure traceability
- **Process security:** 6 megapixel industrial camera module to ensure clear and accurate image recognition;  
1000ul independent pipetting channels ensured accurate dispensing of each sample
- **More suitable for Chinese scientific research work:** multi-point suction; Graphical wizard operation, you can adjust the height



Order No.	Pipetting range	Accuracy of pipetting	Pipetting channel	Bar code scanning	Packaging Specifications
699000	5-1000ul, 1000ul, 200UL, 50ul can be used	5ul<6% 100ul<5%	Independent pipetting channels	The recognition speed was 2 seconds	1set/carton

# Recapper pipetting, Docking module

## Product Feature

- Whole plate recapper and pipette station
- Through the communication port or sensor, the whole box cryogenic tube can be no packing operation by opening -- pipetting -- closing
- Pipetting time: ≤5Seconds
- Customization

Order No.	Packaging Specifications
698000	1set/carton



Noted: 69800 only include docking module, get inquiry for SBS full plate recapper and pipetting station.

The picture only for show workflow

## Cryogenic Vials CAPPING & DECAPPING

### Product Feature

- It is suitable for kinds of caps, diameter of 10-22/19-33mm, Automatically checked cap diameter
- The number of thread turns is adjustable and accuracy is 1/360 turn.
- The speed is 180~240rpm, and the opening time :1.5s.
- 4.3 inch LCD touch screen.
- 240V power supply, suitable for all kinds of power supply, safe operation.

Order No.	Accuracy	Speed	Opening time	Packaging Specifications
695000	1/360 turn	180~240rpm	1.5s	1set/carton

## Low-temperature Label Printers & Labels

### Product Feature

- Thermal printer, resolution 300DPI.
- 3.5-inch color display panel.
- Low temperature labels : -86 degree labels and -196 degrees liquid nitrogen labels ok offer
- Low temperature labels are resistant to chemicals and solvents.
- Customization



Description	Order No.	Size	Temperature	Packaging Specifications
Low-temperature Label Printers	RT6100	—	—	1set/carton
Ribbon	910000	300m	—	1roll/carton
Low Temperature Label	920200	25.5*9.5mm Circle diameter9.5mm	-86°C	3000pcs/carton
Low Temperature Label	950200-1	30*20mm	-86°C	5000pcs/carton
Liquid Nitrogen Label	920201	25.5*9.5mm Circle diameter9.5mm	-196°C	3000pcs/carton

# Sample Management Systems

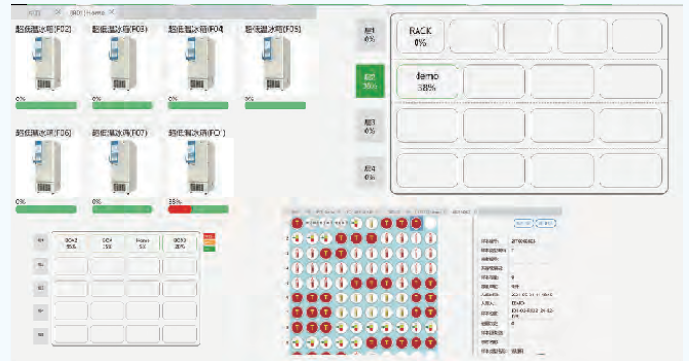

- Login interface sample view, sample management, space management, approval, alarm management, system management, user settings, help information and other functions are clear at a glance.

- The system can visually display the storage containers and equipment in the bacteria bank, and display the graphical interface according to the storage structure of refrigerator-freezer rack-cryoboxes - cryogenic tube

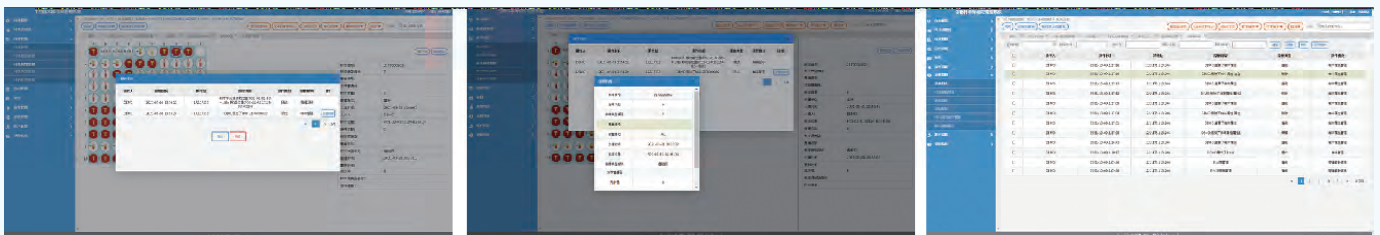

- The system supports the view of storage containers, related operation logs of strain samples, and information change records through the page to ensure the integrity of data records of samples in the library and facilitate the use and traceability of samples.

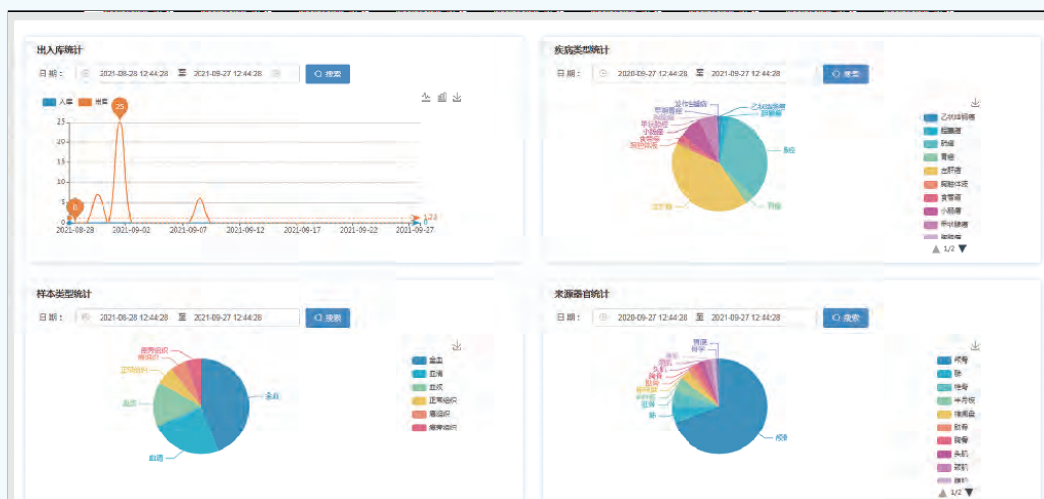

- System supports the user in accordance with the annual, quarterly, and monthly for the relevant amount in the library statistics, according to the sample we related information such as type, name, the custom of fields such as statistics, perspective display icon.





# Screw cap micro tubes -lower cap with O-Ring

## Feature

- Medical Grade Material: USP Biological Reactivity test report ,USP Plastic Class VI grade
- Non-Cytotoxicity
- RNase & Dnase free
- Pyrogen /Endotoxin free
- Heavy metal-free
- Sterile
- Standard 100,000 clean workshop production
- Temperature range: -86 to 121 °C (-186 to 250 °F)
- **CE**

\*Above mentioned can provide third-party reports or associated product reports





- Sarstedet version lower cap line.
- 0.5ml , 1.5ml, 2.0ml for options
- Cap color for options, easy for clarify sample
- Cap new technical : Rotary automatic stripping mold, smooth match with tube and without damping feeling
- Cap bottom design : Gas seal production technology,no leakage under stronger pressure.





- Tube design with skirted base and knurling ,suitable for automatic filling.
- O-ring cap increases cap security (IATA tested)  
Sealing : under -90Kpa ,15mins testing. 40°C constant temperature test
- Comply with the biocompatibility test report
- Strong chemical tolerance to acids, bases and alcohols



Item No.	Volume	Color	Cap style	Sterile	No enzyme	Packaging Specifications
63000Series caps	—	Transparent/transparent Red/transparent Blue/transparent Yellow/transparent Green	Dwarf Cap	No	Yes	500pcs/bag,10bags/carton
6300XSeries caps(x=1,2,3,4,5,6,7,8)	—	Solid/red/green/blue/yellow/purple/orange/white/Brown	Dwarf Cap	No	Yes	500pcs/bag,10bags/carton
630050/51	0.5ml	Transparent/brown	—	No	Yes	500pcs/bag,10bags/carton
630150/151	1.5ml	Transparent/brown	—	No	Yes	500pcs/bag,10bags/carton
630200/201	2.0ml	Transparent/brown	—	No	Yes	500pcs/bag,10bags/carton
630202	2.0ml	Transparent,printing Writing Area And Scale Area	—	No	Yes	500pcs/bag,10bags/carton
63300Series caps	—	Transparent/transparent Red/transparent Blue/transparent Yellow/transparent Green	Dwarf Cap	Yes	Yes	500pcs/bag,10bags/carton
6330XSeries caps(x=1,2,3,4,5,6,7,8)	—	Solid/red/green/blue/yellow/purple/orange/white/Brown	Dwarf Cap	Yes	Yes	500pcs/bag,10bags/carton
633050/51	0.5ml	Transparent/brown	—	Yes	Yes	500pcs/bag,10bags/carton
633150/151	1.5ml	Transparent/brown	—	Yes	Yes	500pcs/bag,10bags/carton
633200/201	2.0ml	Transparent/brown	—	Yes	Yes	500pcs/bag,10bags/carton
633202	2.0ml	Transparent,printing Writing Area And Scale Area	—	Yes	Yes	500pcs/bag,10bags/carton
636050/51	0.5ml	Transparent/brown,tube & Cap Assembled	Dwarf Cap	Yes	Yes	50pcs/bag,40bags/carton
636150/151	1.5ml	Transparent/brown,tube & Cap Assembled	Dwarf Cap	Yes	Yes	50pcs/bag,40bags/carton
636200/201	2.0ml	Transparent/brown,tube & Cap Assembled	Dwarf Cap	Yes	Yes	50pcs/bag,40bags/carton
637200	2.0ml	Transparent,tube & Cap Assembled,printing Writing Area And Scale Area	Dwarf Cap	Yes	Yes	50pcs/bag,40bags/carton

## Dimension

Unit: mm

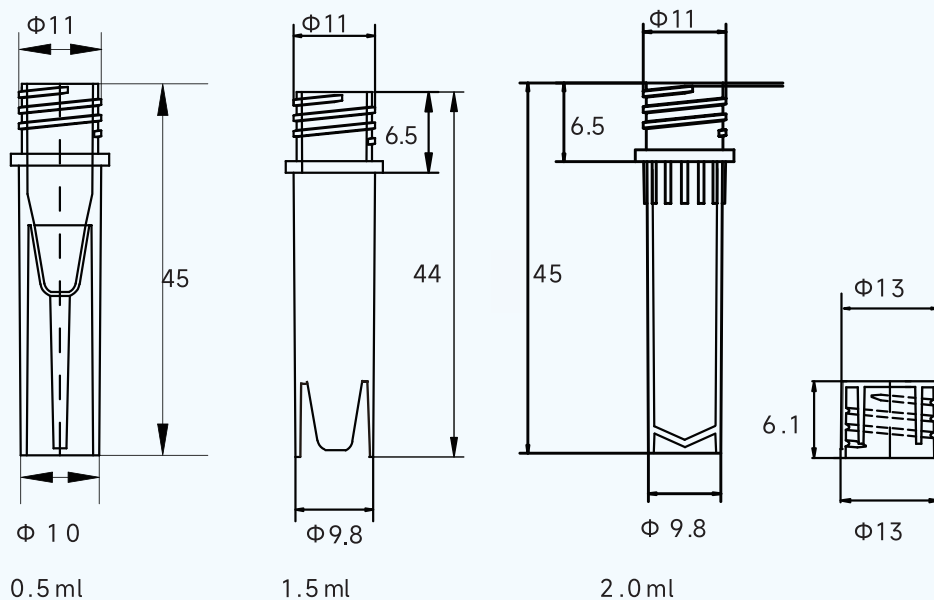

# Screw cap micro tubes --Hinged lower cap, with O-Ring

## Feature

- Sarstedt version lower cap line. Hinged cap
- 0.5ml , 1.5ml, 2.0ml for options
- Cap color for options, easy for clarify sample
- O-ring cap increases cap security (IATA tested)
- Sealing : under -90Kpa ,15mins testing. 40°C constant temperature test



Item No.	Color	Cap style	Sterile	No enzyme	Packaging Specifications
630500/-R/-B/-Y/-G	Transparent/transparent Red/transparent Blue/transparent Yellow/transparent Green	Hinged ,shortcap	No	Yes	500pcs/bag,10bags/carton
63050X[X=1,2,3,4,5,6,7,8]	Solid/red/green/blue/yellow/purple/orange/white/Brown	Hinged ,shortcap	No	Yes	500pcs/bag,10bags/carton
633500/-R/-B/-Y/-G	Transparent/transparent Red/transparent Blue/transparent Yellow/transparent Green	Hinged ,shortcap	Yes	Yes	500pcs/bag,10bags/carton
63350X[X=1,2,3,4,5,6,7,8]	Solid/red/green/blue/yellow/purple/orange/white/Brown	Hinged ,shortcap	Yes	Yes	500pcs/bag,10bags/carton
638050/-R/-B/-Y/-G	Transparent/transparent Red/transparent Blue/transparent Yellow/transparent Green	0.5ml, Tube & cap assembled	Yes	Yes	500pcs/bag,40bags/carton
638050-X[X=1,2,3,4,5,6,7]	Solid/red/green/blue/yellow/purple/orange/white	0.5ml, Tube & cap assembled	Yes	Yes	500pcs/bag,40bags/carton
638051	Brown	0.5ml, Tube & cap assembled	Yes	Yes	500pcs/bag,40bags/carton
638150/-R/-B/-Y/-G	Transparent/transparent Red/transparent Blue/transparent Yellow/transparent Green	1.5ml, Tube & cap assembled	Yes	Yes	500pcs/bag,40bags/carton
638150-X[X=1,2,3,4,5,6,7]	Solid/red/green/blue/yellow/purple/orange/white	1.5ml, Tube & cap assembled	Yes	Yes	500pcs/bag,40bags/carton
638151	Brown	1.5ml, Tube & cap assembled	Yes	Yes	500pcs/bag,40bags/carton
638200/-R/-B/-Y/-G	Transparent/transparent Red/transparent Blue/transparent Yellow/transparent Green	2.0ml, Tube & cap assembled	Yes	Yes	500pcs/bag,40bags/carton
638200-X[X=1,2,3,4,5,6,7]	Solid/red/green/blue/yellow/purple/orange/white	2.0ml, Tube & cap assembled	Yes	Yes	500pcs/bag,40bags/carton
638201	Brown	2.0ml, Tube & cap assembled	Yes	Yes	500pcs/bag,40bags/carton
639200	Transparent	2.0ml, Tube & cap assembled,White Writing area	Yes	Yes	500pcs/bag,40bags/carton





# Screw cap micro tubes -lower cap, without O-Ring

## Feature

- Tube material and function same with microtube lower cap with O-ring
- O-ring cap increases cap security (IATA tested)
- Comply with the biocompatibility test report
- Strong chemical tolerance to acids-bases, alcohols

Item No.	Color	Cap style	Sterile	No enzyme	Packaging Specifications
640000	Transparent	Without O-ring	No	Yes	500pcs/bag,10bags/carton
640001	Transparent Red	Without O-ring	No	Yes	500pcs/bag,10bags/carton
640002	Transparent Blue	Without O-ring	No	Yes	500pcs/bag,10bags/carton
640003	Transparent Yellow	Without O-ring	No	Yes	500pcs/bag,10bags/carton
640004	Transparent Green	Without O-ring	No	Yes	500pcs/bag,10bags/carton
640200	Transparent	2.0ml microtube	No	Yes	500pcs/bag,10bags/carton
643000	Transparent	Without O-ring	Yes	Yes	500pcs/bag,10bags/carton
643001	Transparent Red	Without O-ring	Yes	Yes	500pcs/bag,10bags/carton
643002	Transparent Blue	Without O-ring	Yes	Yes	500pcs/bag,10bags/carton
643003	Transparent Yellow	Without O-ring	Yes	Yes	500pcs/bag,10bags/carton
643004	Transparent Green	Without O-ring	Yes	Yes	500pcs/bag,10bags/carton
643200	Transparent	2.0ml Microtube	Yes	Yes	500pcs/bag,10bags/carton



# Screw cap micro tubes -high cap , with O-Ring, Axygen line

## Feature

- Medical Grade Material: USP Biological Reactivity test report ,USP Plastic Class VI grade
- Non-Cytotoxicity
- Temperature range: -86 to 121 °C (-186 to 250 °F)
- Axygenap line.
- 0.5ml , 1.5ml, 2.0ml for options
- Cap color for options, easy for clarify sample
- O-ring cap increases cap security (IATA tested)
- Sealing : under -90Kpa ,15mins testing. 40°C constant temperature test
- Comply with the biocompatibility test report
- Strong chemical tolerance to acids, bases and alcohols



Item No.	Volume	Color	Color	No enzyme	Packaging Specifications
61000Series caps	—	Transparent/Red/Blue/Yellow/Green	No	Yes	500pcs/bag,10bags/case
61000XSeries caps[X=1,2,3,4,5,6,7]	—	Solid Red/Yellow/Blue/Green/Orange/ White	No	Yes	500pcs/bag,10bags/case
620000 cap	—	Brown	No	Yes	500pcs/bag,10bags/case
610050/51	0.5ml	Transparent/Brown	No	Yes	500pcs/bag,10bags/case
610150/151	1.5ml	Transparent /Brown	No	Yes	500pcs/bag,10bags/case
610200/201	2.0ml	Transparent /Brown	No	Yes	500pcs/bag,10bags/case
610202	2.0ml	Transparent , Scale line	No	Yes	500pcs/bag,10bags/case
613000Series caps	—	Transparent/Red/Blue/Yellow/Green	Yes	Yes	500pcs/bag,10bags/case
61300XSeries caps[X=1,2,3,4,5,6,7]	—	Solid Red/Yellow/Blue/Green/Orange/ White	Yes	Yes	500pcs/bag,10bags/case
623000	—	Brown	Yes	Yes	500pcs/bag,10bags/case
613050/51	0.5ml	Transparent/Brown	Yes	Yes	500pcs/bag,10bags/case
613150/151	1.5ml	Transparent /Brown	Yes	Yes	500pcs/bag,10bags/case
613200/201	2.0ml	Transparent /Brown	Yes	Yes	500pcs/bag,10bags/case
616050/51	0.5ml	Transparent /Brown,Tube & cap assembled	Yes	Yes	50pcs/bag,40bags/case
616150/151	1.5ml	Transparent /Brown,Tube & cap assembled	Yes	Yes	50pcs/bag,40bags/case
616200/201	2.0ml	Transparent /Brown,Tube & cap assembled	Yes	Yes	50pcs/bag,40bags/case
617200	2.0ml	Transparent ,Tube & cap assembled,White Writing area	Yes	Yes	50pcs/bag,40bags/case

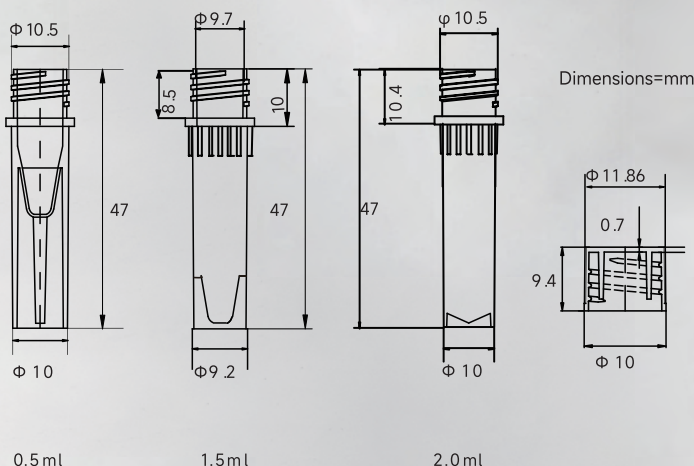



# Reagent bottle

## Feature

- Medical grade PP & HDPE
- RNase & Dnase free , Heavy metal-free
- Volume options:4ml、 8ml ,15ml ,30ml ,60ml, 125ml ,250ml ,500ml ,1000ml
- Bottle one step injection and blowing.
- Open and use without washing
- Cap: PP , bottle : PP & HDPE for options
- PP bottle temperature: High temperature and autoclaving, The embrittleness temperature of PP : zero degree, usually max. Use under 135 degree  
HDPE bottle have better Low temperature storage performance,The embrittleness temperature of PP : -100 degree, usually max. Use under 120 degree





- Acid and alkali resistance: When storing oxidizing materials, organic solvents such as benzene rings, n-hexane and chlorinated hydrocarbons use HDPE bottle
- Toughness and impact resistance :PP bottles have excellent resistance to bending fatigue, but poor impact resistance (especially at low temperatures); HDPE bottle resistance is good,Low temperature storage is not easy to break after impact
- PP is more transparent than HDPE and is more conducive to observing the state of the material stored in the bottle  
HDPE brown bottle 200-800nm full wavelength light protection; USP specifies light transmittance <10%
- Gas (N<sub>2</sub>,O<sub>2</sub>,CO<sub>2</sub>) barrier :HDPE material is obviously superior to PP material

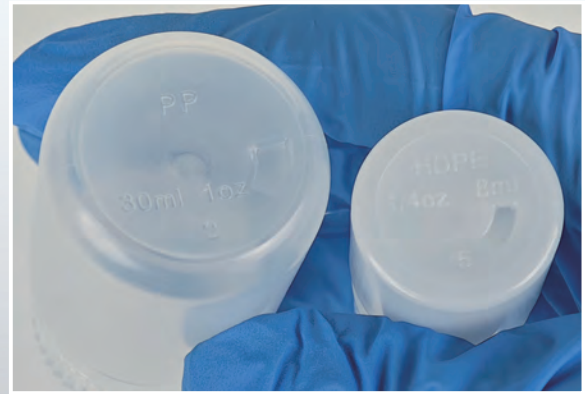

Item No.	Volume	Material	Color	Sterile	No enzyme	Packaging Specifications
5X0004	4ml	PP Cap, PP Bottle	Transparent	X=0, No Sterile; when X=5, Sterilized	Yes	X=0, 200caps/bag, 200tubes/bag, 2000sets/case; X=5, 100pcs/bag, 10bags/case
5X2004	4ml	PP Cap, HDPE Bottle	Dark brown	X=0, No Sterile; when X=5, Sterilized	Yes	X=0, 200caps/bag, 200tubes/bag, 2000sets/case; X=5, 100pcs/bag, 10bags/case
5X0008	8ml	PP Cap, PP Bottle	Transparent	X=0, No Sterile; when X=5, Sterilized	Yes	X=0, 100caps/bag, 100tubes/bag, 1000sets/case; X=5, 20pcs/bag, 20bags/case
5X1008	8ml	PP Cap, HDPE Bottle	Natural color	X=0, No Sterile; when X=5, Sterilized	Yes	X=0, 100caps/bag, 100tubes/bag, 1000sets/case; X=5, 20pcs/bag, 20bags/case
5X2008	8ml	PP Cap, HDPE Bottle	Dark brown	X=0, No Sterile; when X=5, Sterilized	Yes	X=0, 100caps/bag, 100tubes/bag, 1000sets/case; X=5, 20pcs/bag, 20bags/case
5X0015	15ml	PP Cap, PP Bottle	Transparent	X=0, No Sterile; when X=5, Sterilized	Yes	X=0, 100caps/bag, 100tubes/bag, 1000sets/case; X=5, 20pcs/bag, 20bags/case
5X1015	15ml	PP Cap, HDPE Bottle	Natural color	X=0, No Sterile; when X=5, Sterilized	Yes	X=0, 100caps/bag, 100tubes/bag, 1000sets/case; X=5, 20pcs/bag, 20bags/case
5X2015	15ml	PP Cap, HDPE Bottle	Dark brown	X=0, No Sterile; when X=5, Sterilized	Yes	X=0, 100caps/bag, 100tubes/bag, 1000sets/case; X=5, 20pcs/bag, 20bags/case
5X0030	30ml	PP Cap, PP Bottle	Transparent	X=0, No Sterile; when X=5, Sterilized	Yes	X=0, 100caps/bag, 100tubes/bag, 1000sets/case; X=5, 20pcs/bag, 20bags/case
5X1030	30ml	PP Cap, HDPE Bottle	Natural color	X=0, No Sterile; when X=5, Sterilized	Yes	X=0, 100caps/bag, 100tubes/bag, 1000sets/case; X=5, 20pcs/bag, 20bags/case
5X2030	30ml	PP Cap, HDPE Bottle	Dark brown	X=0, No Sterile; when X=5, Sterilized	Yes	X=0, 100caps/bag, 100tubes/bag, 1000sets/case; X=5, 20pcs/bag, 20bags/case
5X0060	60ml	PP Cap, PP Bottle	Transparent	X=0, No Sterile; when X=5, Sterilized	Yes	X=0, 50caps/bag, 50tubes/bag, 500sets/case; X=5, 10pcs/bag, 20bags/case
5X1060	60ml	PP Cap, HDPE Bottle	Natural color	X=0, No Sterile; when X=5, Sterilized	Yes	X=0, 50caps/bag, 50tubes/bag, 500sets/case; X=5, 10pcs/bag, 20bags/case
5X2060	60ml	PP Cap, HDPE Bottle	Dark brown	X=0, No Sterile; when X=5, Sterilized	Yes	X=0, 50caps/bag, 50tubes/bag, 500sets/case; X=5, 10pcs/bag, 20bags/case
5X0125	125ml	PP Cap, PP Bottle	Transparent	X=0, No Sterile; when X=5, Sterilized	Yes	X=0, 25caps/bag, 25tubes/bag, 250sets/case; X=5, 10pcs/bag, 10bags/case
5X1125	125ml	PP Cap, HDPE Bottle	Natural color	X=0, No Sterile; when X=5, Sterilized	Yes	X=0, 25caps/bag, 25tubes/bag, 250sets/case; X=5, 10pcs/bag, 10bags/case
5X2125	125ml	PP Cap, HDPE Bottle	Dark brown	X=0, No Sterile; when X=5, Sterilized	Yes	X=0, 25caps/bag, 25tubes/bag, 250sets/case; X=5, 10pcs/bag, 10bags/case
5X0250	250ml	PP Cap, PP Bottle	Transparent	X=0, No Sterile; when X=5, Sterilized	Yes	X=0, 20caps/bag, 20tubes/bag, 200sets/case; X=5, 10pcs/bag, 10bags/case
5X1250	250ml	PP Cap, HDPE Bottle	Natural color	X=0, No Sterile; when X=5, Sterilized	Yes	X=0, 20caps/bag, 20tubes/bag, 200sets/case; X=5, 10pcs/bag, 10bags/case
5X2250	250ml	PP Cap, HDPE Bottle	Dark brown	X=0, No Sterile; when X=5, Sterilized	Yes	X=0, 20caps/bag, 20tubes/bag, 200sets/case; X=5, 10pcs/bag, 10bags/case
5X0500	500ml	PP Cap, PP Bottle	Transparent	X=0, No Sterile; when X=5, Sterilized	Yes	X=0, 10caps/bag, 10tubes/bag, 100sets/case; X=5, 5pcs/bag, 10bags/case
5X1500	500ml	PP Cap, HDPE Bottle	Natural color	X=0, No Sterile; when X=5, Sterilized	Yes	X=0, 10caps/bag, 10tubes/bag, 100sets/case; X=5, 5pcs/bag, 10bags/case
5X2500	500ml	PP Cap, HDPE Bottle	Dark brown	X=0, No Sterile; when X=5, Sterilized	Yes	X=0, 10caps/bag, 10tubes/bag, 100sets/case; X=5, 5pcs/bag, 10bags/case
5X1001	1000ml	PP Cap, PP Bottle	Transparent	X=0, No Sterile; when X=5, Sterilized	Yes	X=0, 5caps/bag, 5tubes/bag, 100sets/case; X=5, 5pcs/bag, 10bags/case
5X1101	1000ml	PP Cap, HDPE Bottle	Natural color	X=0, No Sterile; when X=5, Sterilized	Yes	X=0, 5caps/bag, 5tubes/bag, 100sets/case; X=5, 5pcs/bag, 10bags/case
5X1201	1000ml	PP Cap, HDPE Bottle	Dark brown	X=0, No Sterile; when X=5, Sterilized	Yes	X=0, 5caps/bag, 5tubes/bag, 100sets/case; X=5, 5pcs/bag, 10bags/case

# Media Bottle

## Feature

- Medical grade PETG
- High clear
- Rectangle shape, easy for hold and shipping
- E-Beam sterile, DNase & Rnase free, Non-endotoxin
- Temperature range: -86 to 60 °C (-186 to 140 °F)



125ml

250ml

500ml

1000ml

Dimensions=mm





- Cap : Rotary production process , easy and smooth match with bottle.
- Bottle : one step injection and blowing. No need wash and open use directly
- Clear and accurate scale, range 0.1mm

**Volume Range**

Nominal (ml)	Extreme deviation(ml)	Average(ml)
0-250	+6 -4	≥0
500	+8 -5	≥0
1000	+11 -6	≥0

Item No.	Volume	Materia	Sterile	No enzyme	Packaging Specifications
590005	5ml	PETG	Yes	Yes	100pcs/bag,5bags/case
590010	10ml	PETG	Yes	Yes	100pcs/bag,5bags/case
590030	30ml	PETG	Yes	Yes	40pcs/bag,7bags/case
590060	60ml	PETG	Yes	Yes	40pcs/bag,5bags/case
590125	125ml	PETG	Yes	Yes	10pcs/bag,10bags/carton
590250	250ml	PETG	Yes	Yes	30pcs/bag,2bags/case
590500	500ml	PETG	Yes	Yes	24pcs/bag,2bags/case
591000	1000ml	PETG	Yes	Yes	12pcs/bag,4bags/case

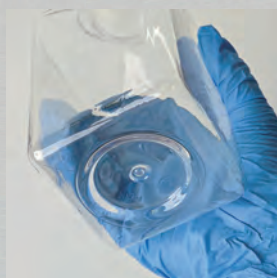

# Sample tubes

## Feature

- Medical grade PP tube, Cap PE
- 5ml, 6ml, 10ml, 20ml ,30ml for options
- DNase & Rnase free, Non-endotoxin, Heavy metal free
- -80Kpa test
- E-beam sterile

Item No.	Volume	Scale on tube	Sterile	No enzyme	Packaging Specifications
650005	5ml	No	No	Yes	500caps/bag,500tubes/bag,1000sets/case
650006	6ml	No	No	Yes	500caps/bag,500tubes/bag,1000sets/case
650010	10ml	Have	No	Yes	250caps/bag,250tubes/bag,1000sets/case
650020	20ml	No	No	Yes	200caps/bag,200tubes/bag,1000sets/case
650030	30ml	No	No	Yes	200caps/bag,200tubes/bag,800sets/case
650105	5ml	No	Yes	Yes	25pcs/bags,500pcs/case
650106	6ml	No	Yes	Yes	25pcs/bags,500pcs/case
650110	10ml	Have	Yes	Yes	25pcs/bags,500pcs/case
650120	20ml	No	Yes	Yes	25pcs/bags,500pcs/case
650130	30ml	No	Yes	Yes	25pcs/bags,500pcs/case

Item No.	Fit	Hole count	Packaging Specifications
650121-R (Sample tube holder)	5ml squat sample tube, 10ml sample tube	8*12=96 holes	50pcs/carton
650020-R(Sample tube holder)	20ml sample tube	6*8=48 holes	50pcs/carton
650030-R(Sample tube holder)	30ml sample tube	6*8=48 holes	50pcs/carton

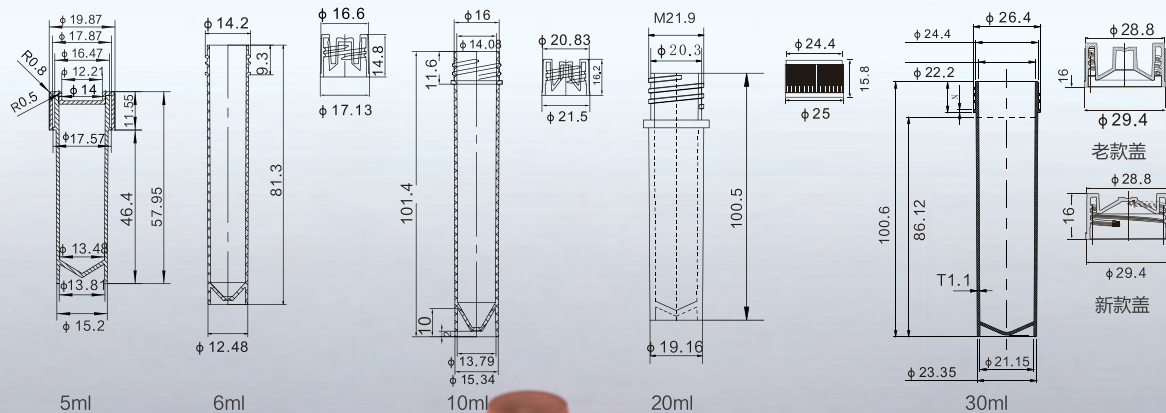

Dimensions=mm

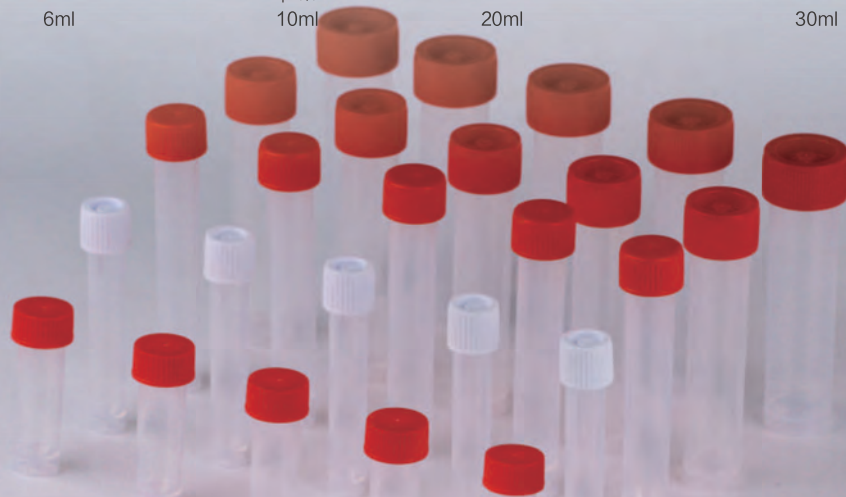



# Reagent Reservoir

## Feature

- SBS International standard, all products confirm to SBS international standard, are compatible with most of pipette workstations.
- Medical grade PP, imported virgin material
- More size and volume for options
- High temperature sterilization autoclavable at 121°C /15psi
- Non-enzyme, non-Pyrogen

Item No.	Channel	Profile	No enzyme	Packaging Specifications
730001	Flat Channel--single Channe	Single Well, Middle Profile	Yes	5 pcs/bag, 50 pcs/carton
730008	8 Channe--multi Channe	Multi Well, Middle Profile	Yes	5 pcs/bag, 50 pcs/carton
730012	12 Channel--multi Channe	Multi Well, Middle Profile	Yes	5 pcs/bag, 50 pcs/carton
730096	96 Channel --single Channe	Single Well, Middle Profile	Yes	5 pcs/bag, 50 pcs/carton
730384	384 Channel --single Channe	Single Well, Middle Profile	Yes	5 pcs/bag, 50 pcs/carton
732008	8 Channel --multi Channe	Multi Well, High Profile	Yes	5 pcs/bag, 50 pcs/carton
732012	12 Channe--multi Channe	Multi Well, High Profile	Yes	5 pcs/bag, 50 pcs/carton
731001	8 Channel --single Channe	Single Well, High Profile	Yes	5 pcs/bag, 50 pcs/carton
731008	12 Channel --single Channe	Single Well, High Profile	Yes	5 pcs/bag, 50 pcs/carton
731096	96 Channel --single Channe	Single Well, High Profile	Yes	5 pcs/bag, 50 pcs/carton
731384	384 Channel --single Channe	Single Well, High Profile	Yes	5 pcs/bag, 50 pcs/carton

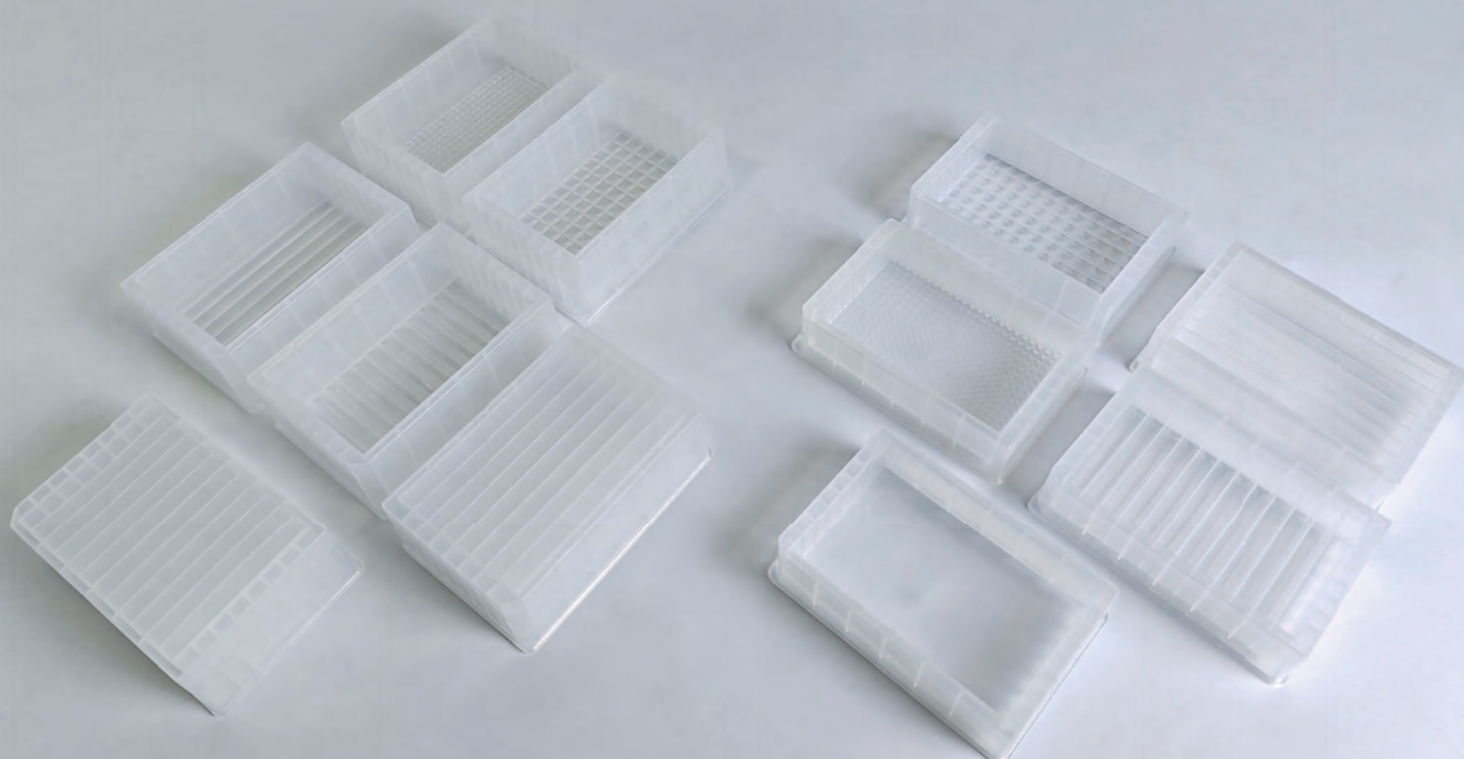



# Deep Well Plates

## Feature

- Medial grade PP material
- Available in U bottom and V bottom
- Ok sterilized by high temperature and high pressure, matched with sealing film
- Compliant with SBS international standard

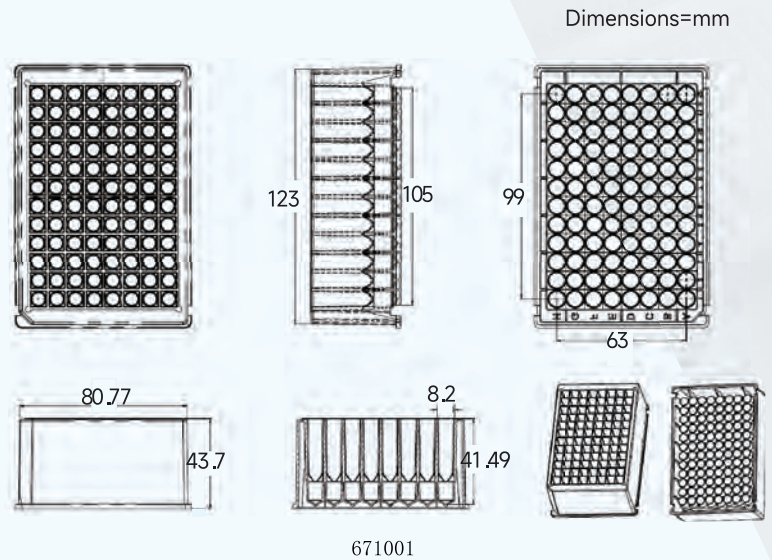
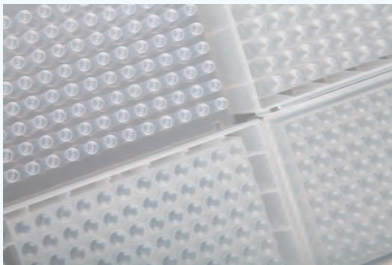

Item No.	Volume	Des.	Style	Sterile	Sterile	Packaging Specifications
671101	1.0ml	rectangle	V bottom	No	Yes	5pcs/bag,10bags/case
671102	1.0ml	rectangle	U bottom	No	Yes	5pcs/bag,10bags/case
671601	1.6ml	rectangle	V bottom	No	Yes	5pcs/bag,10bags/case
671602	1.6ml	rectangle	U bottom	No	Yes	5pcs/bag,10bags/case
671001	2.2ml	rectangle	V bottom	No	Yes	5pcs/bag,10bags/case
671002	2.2ml	rectangle	U bottom	No	Yes	5pcs/bag,10bags/case
671003	2.2ml	rectangle	I-shaped board	No	Yes	5pcs/bag,10bags/case
673101	1.0ml	Round	V bottom	No	Yes	5pcs/bag,10bags/case
673102	1.0ml	Round	U bottom	No	Yes	5pcs/bag,10bags/case
673001	2.0ml	Round	V bottom	No	Yes	5pcs/bag,10bags/case
673002	2.0ml	Round	U bottom	No	Yes	5pcs/bag,10bags/case
672000	—	96-Strip Rod Comb	—	No	Yes	10pcs/bag,10bags/case

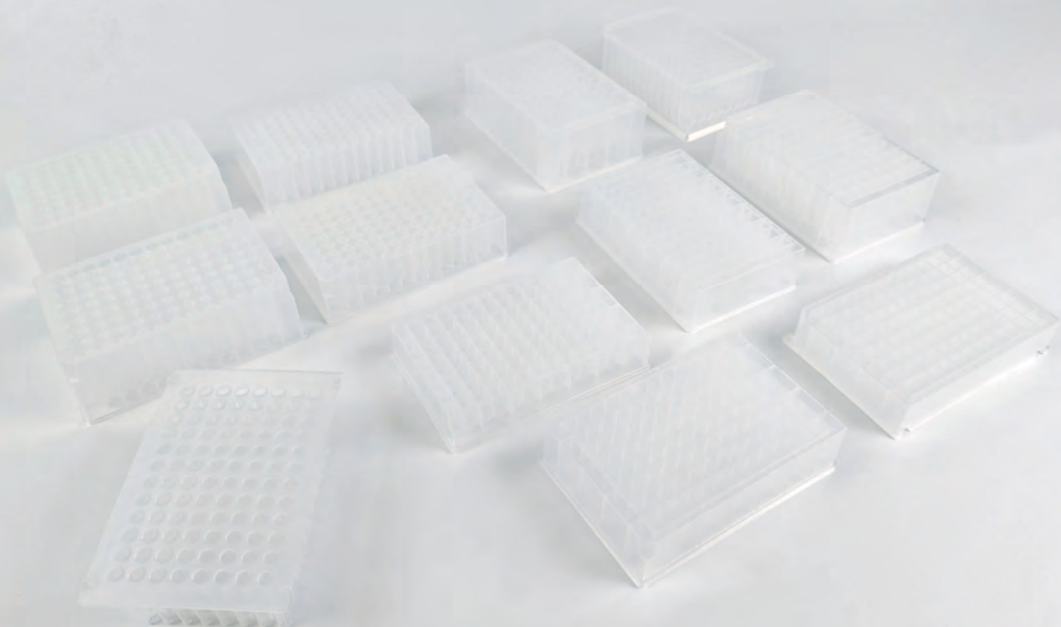

# Hamilton Automatic Pipette Tips

## Feature

- Medical grade PP material
- Low absorption treatment, Reduction of residue
- Uniform resistance and CV values
- E-beam sterilization, DNase & RNase free, Non- pyrogen
- Hamilton automated tips for Hamilton series workstations

Item No.	Volume	Color	Low Adsorption	Filter or No Filter	Sterile No enzyme	Packaging Specifications
H490302	300µL	Black	Yes	No	Yes	96tips/rack,6racks/inner box,30racks/case
H490303	300µL	Black	Yes	Yes	Yes	96tips/rack,6racks/inner box,30racks/case
H491002	1000µL	Black	Yes	No	Yes	96tips/rack,5racks/inner box,25racks/case
H491003	1000µL	Black	Yes	Yes	Yes	96tips/rack,5racks/inner box,25racks/case

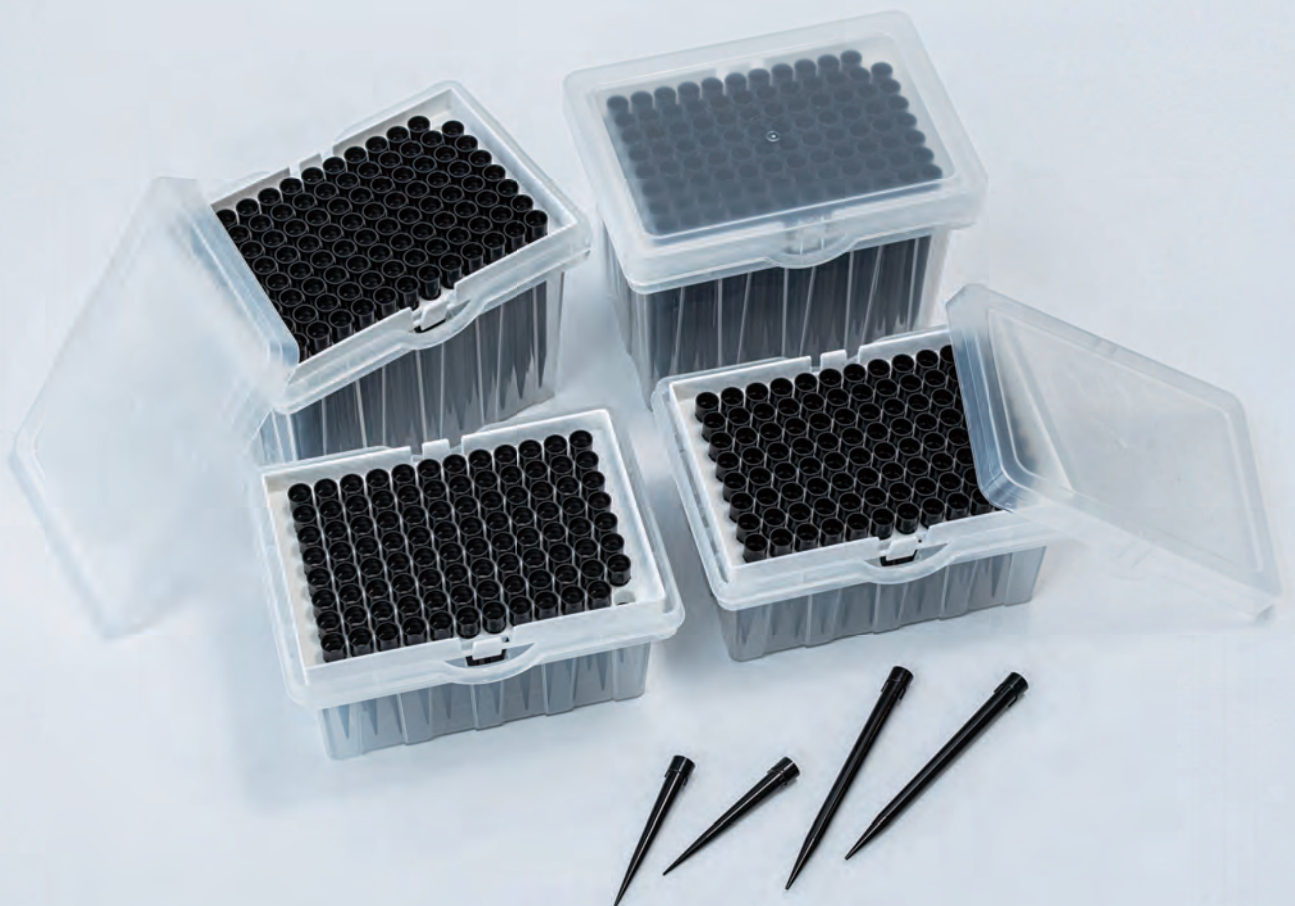



# Tecan Automatic Pipette

## Feature

- Medical grade PP material
- Low absorption treatment, Reduction of residue
- Uniform resistance and CV values
- E-beam sterilization, DNase & RNase free, Non- pyrogen
- Tecan automated tips for Tecan series workstations

Item No.	Volume	Color	Low Adsorption	Filter or No Filter	Steriled,Non-enzyme	Packaging Specifications
T420020	20 $\mu$ L	Transparent	No	No	Yes	96tips/rack ,10racks/inner box,50racks/carton
T420021	20 $\mu$ L	Transparent	No	Have	Yes	96tips/rack ,10racks/inner box,50racks/carton
T420022	20 $\mu$ L	Black	No	No	Yes	96tips/rack ,10racks/inner box,50racks/carton
T420023	20 $\mu$ L	Black	No	Have	Yes	96tips/rack ,10racks/inner box,50racks/carton
T420050	50 $\mu$ L	Transparent	No	No	Yes	96tips/rack ,10racks/inner box,50racks/carton
T420051	50 $\mu$ L	Transparent	No	Have	Yes	96tips/rack ,10racks/inner box,50racks/carton
T420052	50 $\mu$ L	Black	No	No	Yes	96tips/rack ,10racks/inner box,50racks/carton
T420053	50 $\mu$ L	Black	No	Have	Yes	96tips/rack ,10racks/inner box,50racks/carton
T490200	200 $\mu$ L	Transparent	Yes	No	Yes	96tips/rack,6racks/Inner box,30racks/carton
T490201	200 $\mu$ L	Transparent	Yes	Have	Yes	96tips/rack,6racks/Inner box,30racks/carton
T490202	200 $\mu$ L	Black	Yes	No	Yes	96tips/rack,6racks/Inner box,30racks/carton
T490203	200 $\mu$ L	Black	Yes	Have	Yes	96tips/rack,6racks/Inner box,30racks/carton
T491000	1000 $\mu$ L	Transparent	Yes	No	Yes	96tips/rack,5racks/Inner box,25racks/carton
T491001	1000 $\mu$ L	Transparent	Yes	Have	Yes	96tips/rack,5racks/Inner box,25racks/carton
T491002	1000 $\mu$ L	Black	Yes	No	Yes	96tips/rack,5racks/Inner box,25racks/carton
T491003	1000 $\mu$ L	Black	Yes	Have	Yes	96tips/rack,5racks/Inner box,25racks/carton

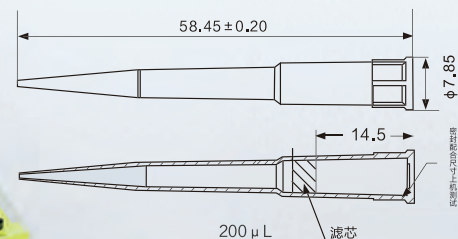
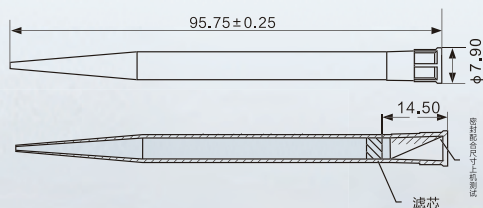

Dimensions=mm

1000  $\mu$  L

200  $\mu$  L

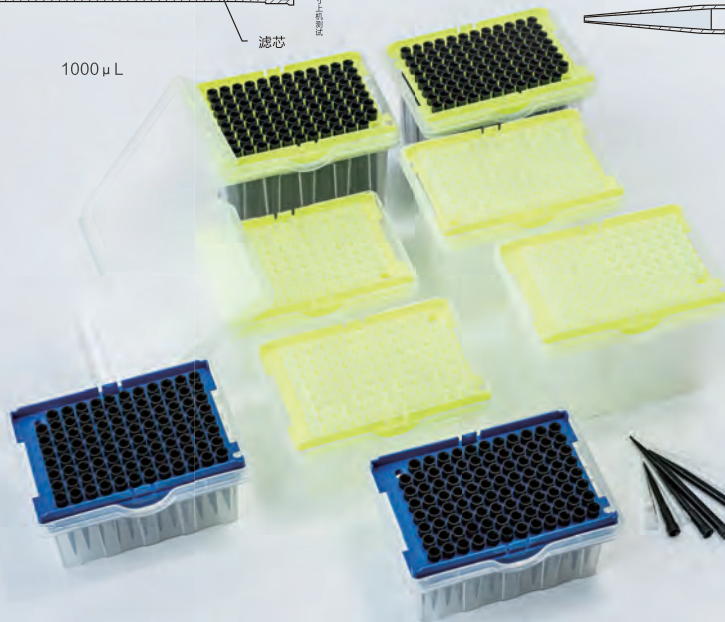



# Beckman Automatic Pipette

## Feature

- Medical grade PP material
- Low absorption treatment, Reduction of residue
- Uniform resistance and CV values
- E-beam sterilization, DNase & RNase free, Non- pyrogen
- Beckman automated tips are adapted to the Beckman series of workstations

Item No.	Volume	Color	Low Adsorption	Filter or No Filter	Sterility	Non-enzyme	Packaging Specifications
B490050	50µL	Transparent	No	No	Yes	Yes	96tips/rack,50racks/carton
B490051	50µL	Transparent	Yes	No	Yes	Yes	96tips/rack,50racks/carton
B490052	50µL	Transparent	No	Have	Yes	Yes	96tips/rack,50racks/carton
B490053	50µL	Transparent	Yes	Have	Yes	Yes	96tips/rack,50racks/carton
B490250	250µL	Transparent	No	No	Yes	Yes	96tips/rack,50racks/carton
B490251	250µL	Transparent	Yes	No	Yes	Yes	96tips/rack,50racks/carton
B490252	250µL	Transparent	No	Have	Yes	Yes	96tips/rack,50racks/carton
B490253	250µL	Transparent	Yes	Have	Yes	Yes	96tips/rack,50racks/carton



# Saliva Collectors

## Feature

- Safety: Painless, Non-Invasive, No Cross Infection
- Portable: Transport at room temperature, storage at room temperature for 24 months after sampling, DNA will not degrade
- Efficient: A large amount of DNA was obtained, High efficiency of extraction.
- Barcode: Each sample has a unique international standard barcode, which regulates sample management and protects the subject's privacy.

Item No.	Volume	Tube Graduate	Sterile	Non-enzyme	Packaging Specifications
652005	5ml	No	No	Yes	1000sets/case
652011	10ml	Yes	No	Yes	1000sets/case
652505	5ml	No	No	Yes	Blister box independent packaging,400sets/case
652505-s	5ml	No	Yes	Yes	Individule PE bag pack ,400sets/case
652511	10ml	Yes	No	Yes	Blister box independent packaging,275sets/case
652511-s	10ml	Yes	No	Yes	Individule PE bag pack ,275sets/case
652000	--	--	No	Yes	100pcs/bag, 1000pcs/carton

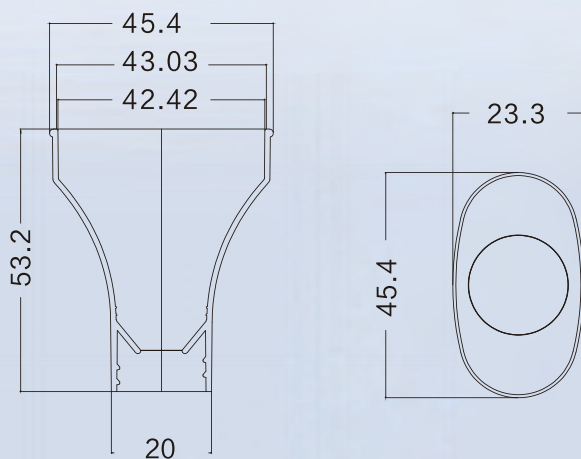

650006

Dimensions=mm



# AMNGENT

## 安进特

ZHEJIANG RONGDA BIOTECHNOLOGY CO., LTD.

Tel: 0576-84080099

Website: [www.rongda-bio.com](http://www.rongda-bio.com)

Address: Building 1, No. 999, Beiyuan Road,  
Xinqian street, HuangyanArea, Taizhou City,  
Zhejiang Province, China

